

Quantum
Radiation
group

Max-Planck Institute
for the Science
of Light



PHASE SUPERSENSITIVITY IN AN UNBALANCED $SU(1,1)$ INTERFEROMETER

Maria Chekhova

*Max-Planck Institute for the Science of Light,
Erlangen, Germany*

QUANTUM RADIATION GROUP



**Farid Khalili,
Moscow State
University**



OUTLINE

- 1. Nonlinear $SU(1,1)$ interferometer**
- 2. Phase sensitivity**
- 3. Gain unbalancing and loss tolerance**
- 4. Experiment**
- 5. Conclusions**

NONLINEAR INTERFEROMETER

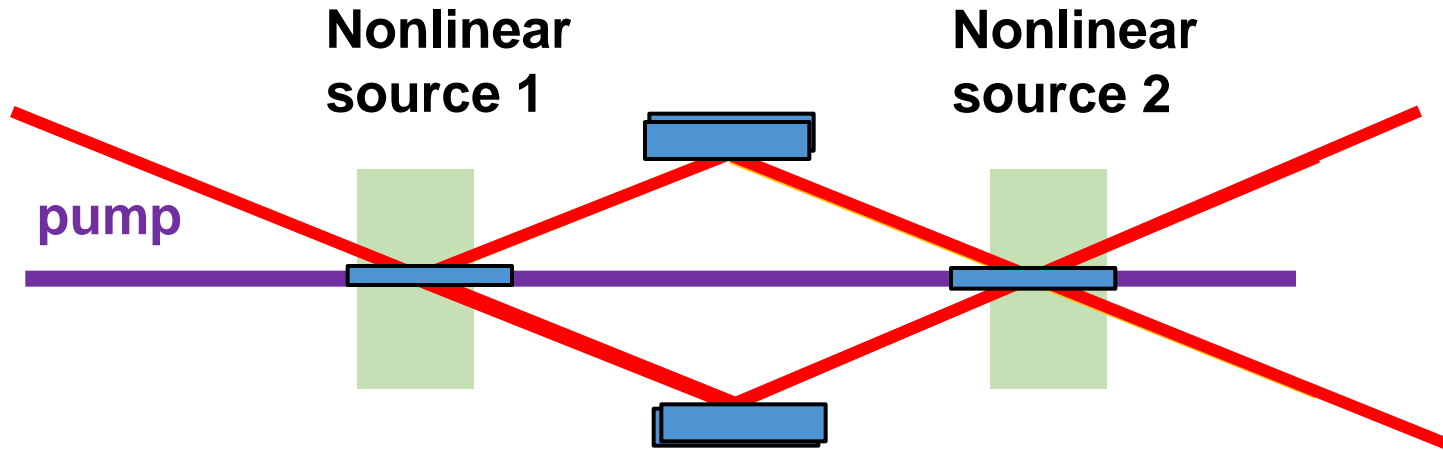

Linear Mach-Zehnder interferometer

Nonlinear Mach-Zehnder interferometer

SU(1,1) INTERFEROMETER

Parametric down-conversion or four-wave mixing

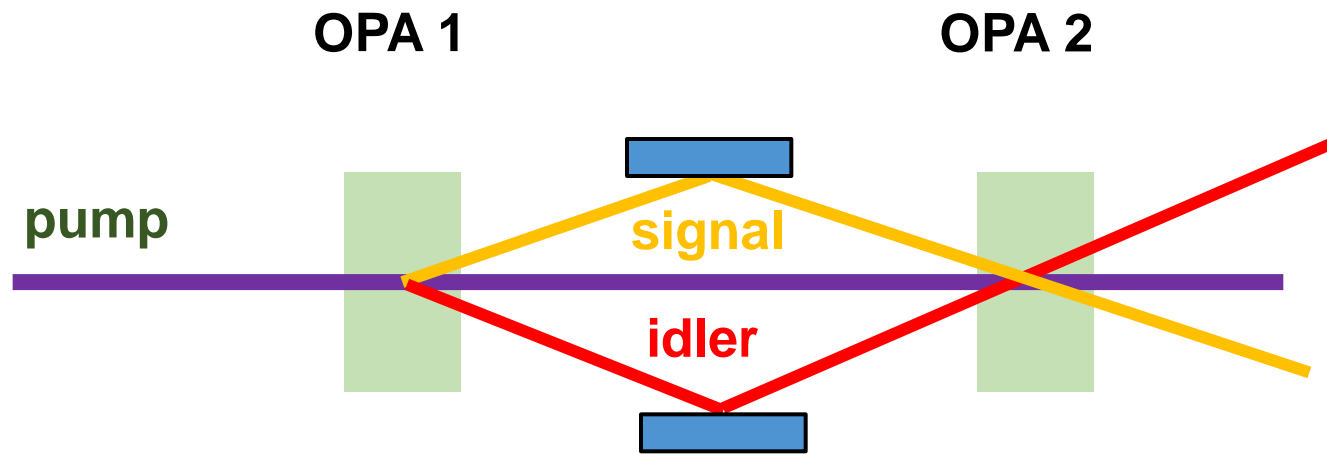

B. Yurke, S.L. McCall, and J.R. Klauder, PRA 33, 4033 (1986)

SU(2) AND SU(1,1) INTERFEROMETERS

SU(2) interferometer

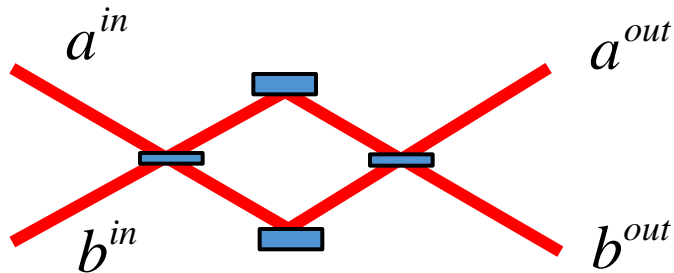

$$\begin{pmatrix} a^{out} \\ b^{out} \end{pmatrix} = \mathbf{U} \begin{pmatrix} a^{in} \\ b^{in} \end{pmatrix},$$

$$|U_{11}|^2 + |U_{12}|^2 = 1,$$

$$U_{21} = -U_{12}^*, U_{22} = U_{11}^*$$

**‘beamsplitter’,
SU(2) group**

SU(1,1) interferometer

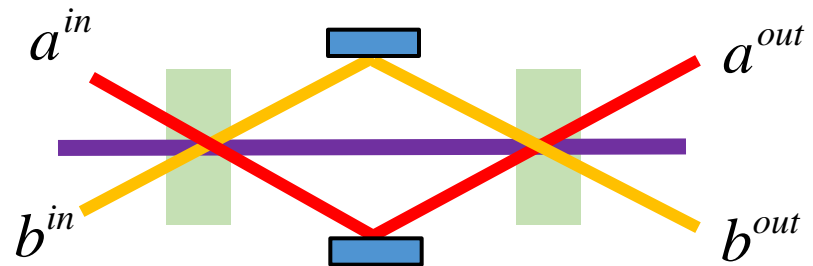

$$\begin{pmatrix} a^{out} \\ [b^{out}]^+ \end{pmatrix} = \mathbf{S} \begin{pmatrix} a^{in} \\ [b^{in}]^+ \end{pmatrix},$$

$$|S_{11}|^2 - |S_{12}|^2 = 1, |S_{22}|^2 - |S_{21}|^2 = 1,$$

$$S_{11}S_{21}^* = S_{12}S_{22}^*$$

**‘Bogolyubov’,
SU(1,1) group**

SU(1,1) INTERFEROMETER: BIPHOTON PHASE CHARACTERIZATION

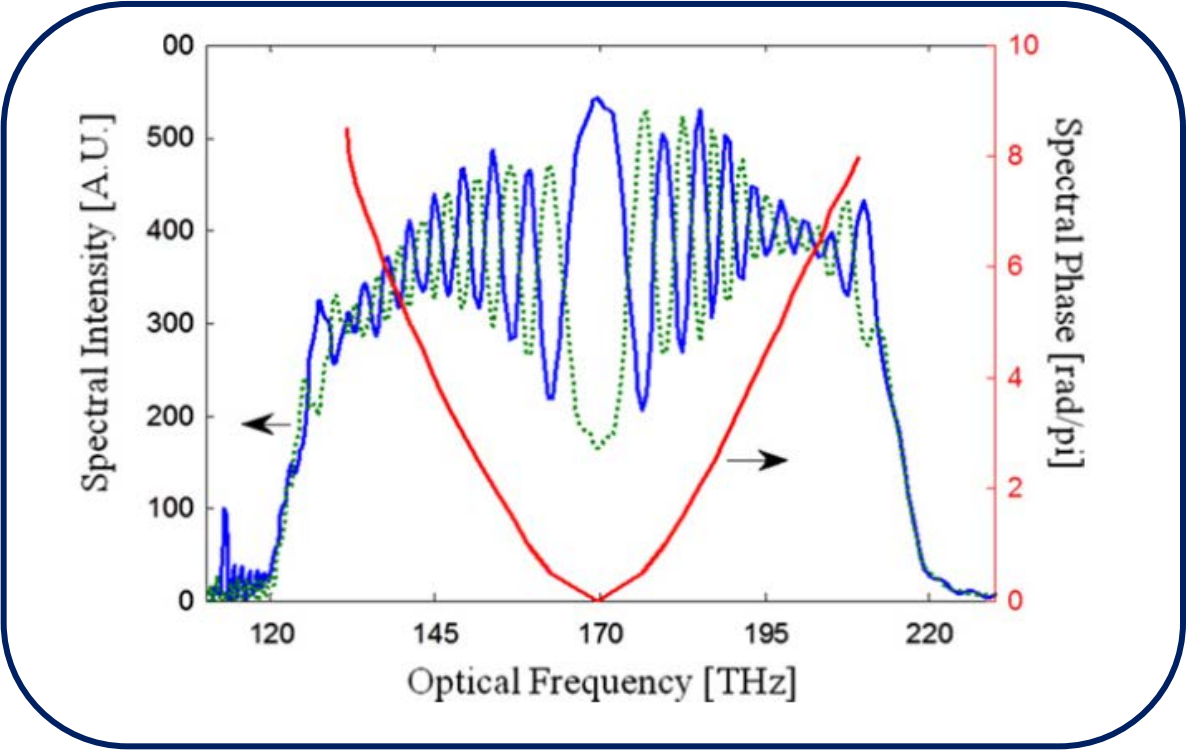
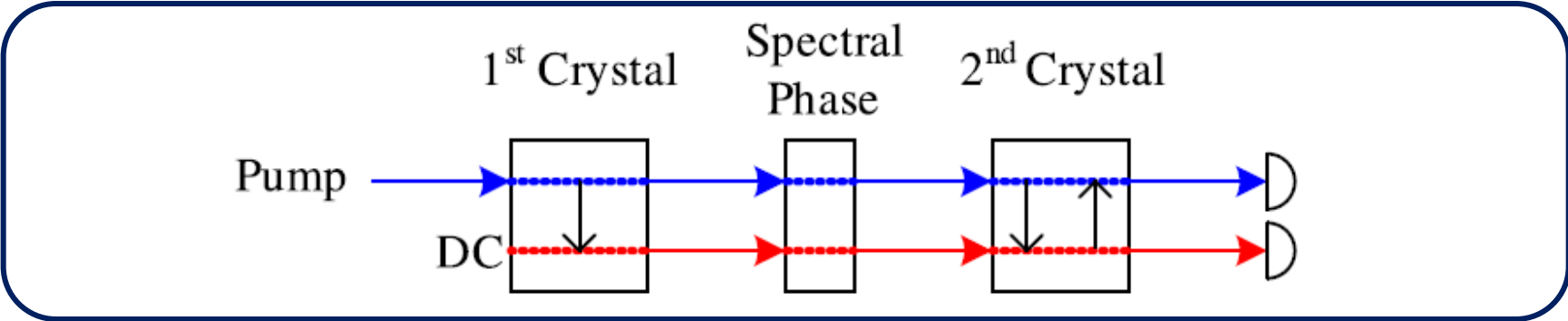

Amplification or deamplification in the second crystal, depending on the phase: enables the phase retrieval

Y. Shaked, R. Pomerantz, R. Z. Vered, and A. Pe'er, NJP 16, 053012 (2014)

HIGH-GAIN SU(1,1) INTERFEROMETER: SPECTRUM SHAPING

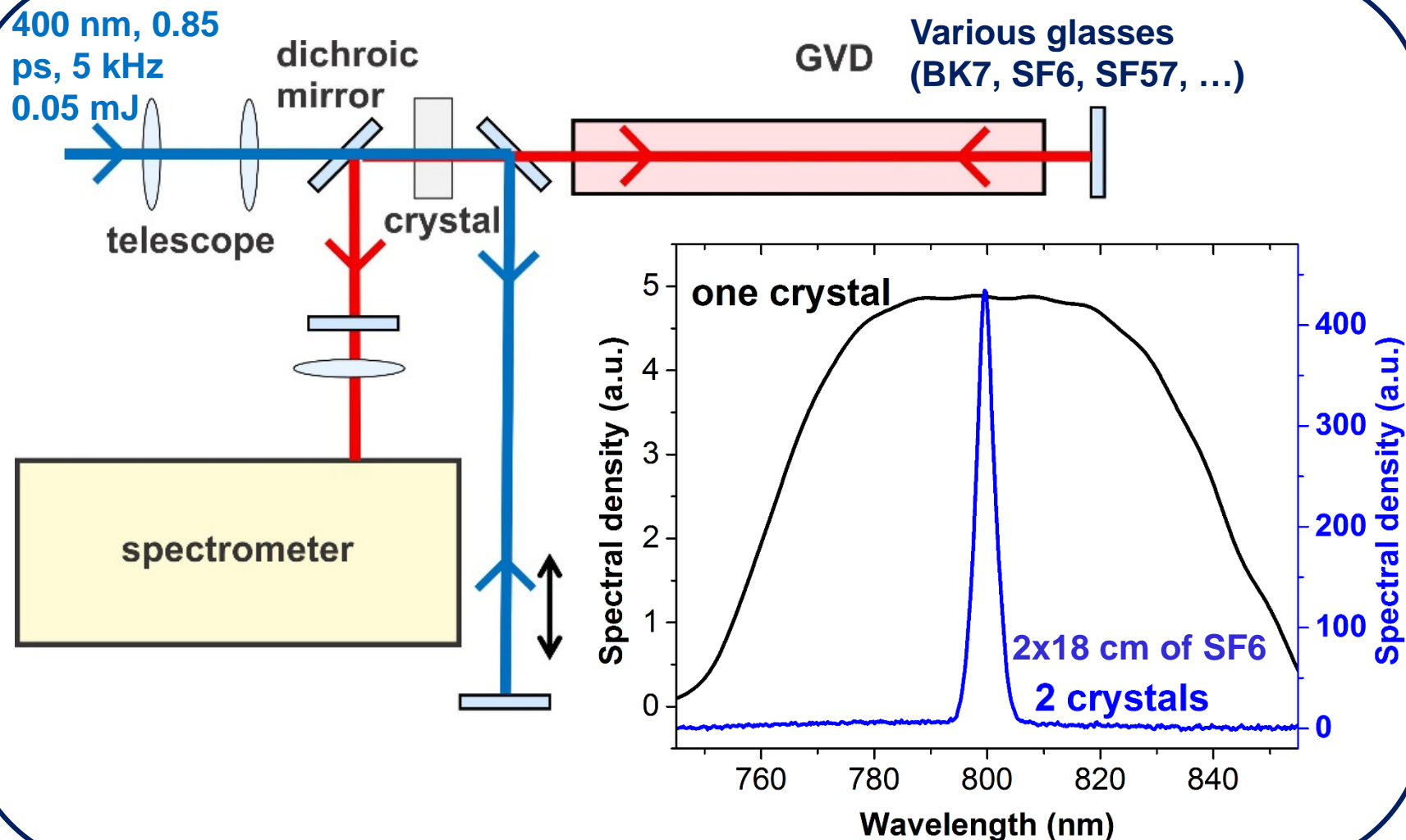

S. Lemieux, M. Manceau, P. R. Sharapova, O. V. Tikhonova, R. W. Boyd, G. Leuchs, and M. V. Chekhova, Phys. Rev. Lett. 117, 183601 (2016).

PHASE SENSITIVITY

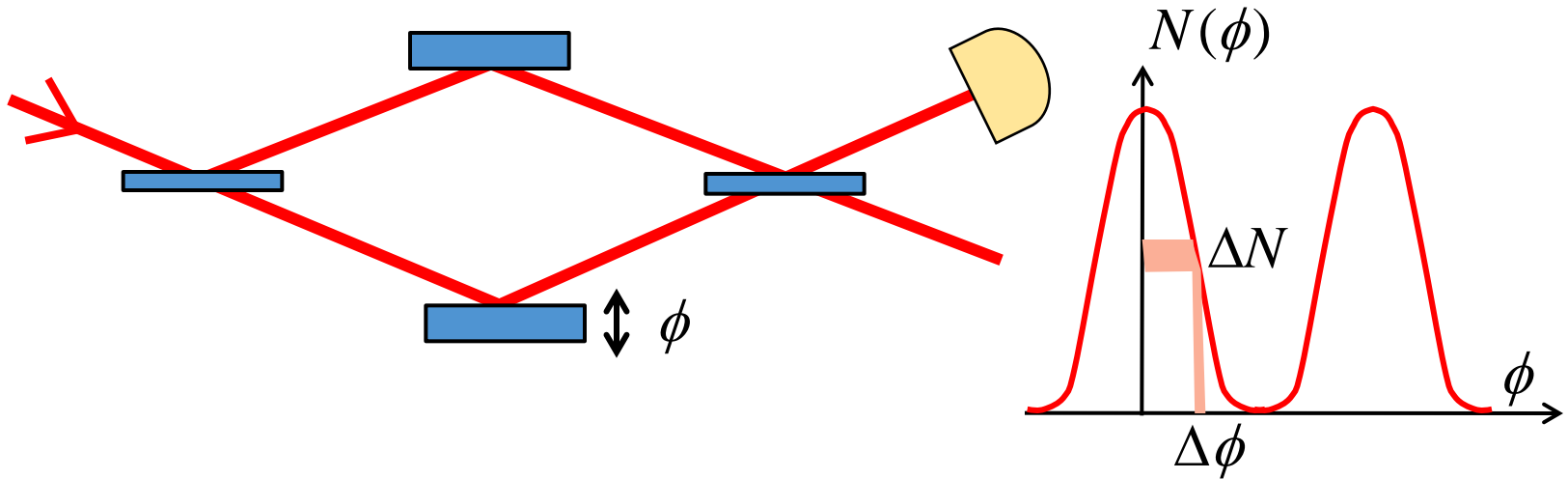

$$\Delta\phi = \frac{\Delta N}{|dN/d\phi|}$$

**Shot-noise limit
(coherent state)**

$$\Delta\phi_{SNL} = \frac{1}{\sqrt{\langle N \rangle}}$$

Phase supersensitive measurement: $\Delta\phi < \Delta\phi_{SNL}$

**Heisenberg limit (exotic
states like NOON):**

$$\Delta\phi_H \sim \frac{1}{\langle N \rangle}$$

HIGH-GAIN SU(1,1) INTERFEROMETER: PHASE SUPERSENSITIVITY

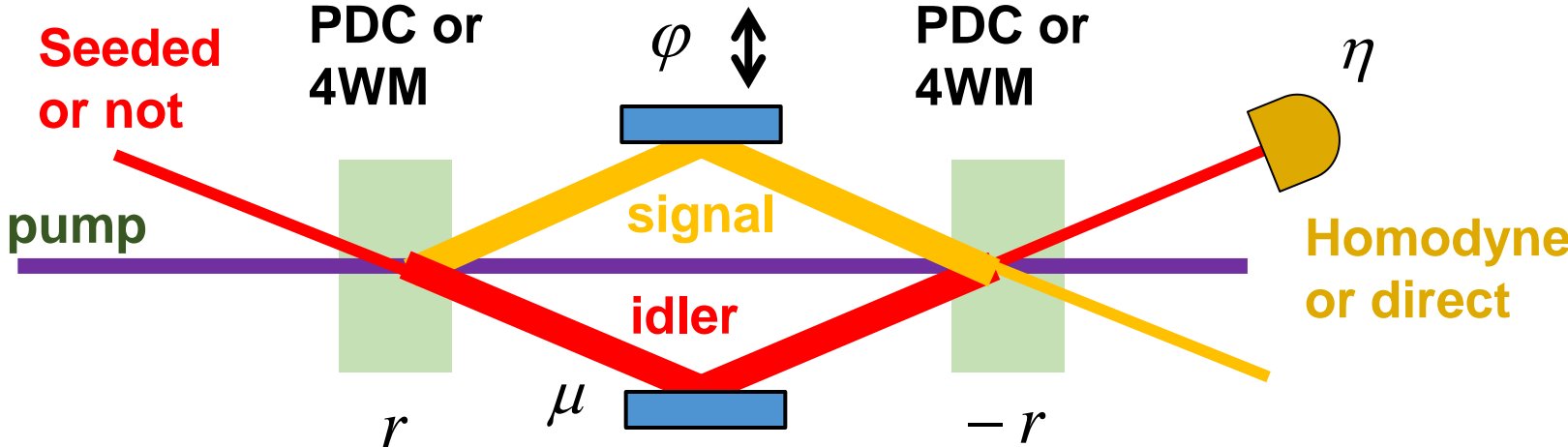

No losses: Heisenberg limit

$$\Delta\phi \sim \frac{1}{\langle N \rangle}$$

Internal transmission μ , external η :

$$\Delta\phi = \frac{1}{\sqrt{\langle N \rangle}} \sqrt{\frac{1 - \eta + \mu\eta e^{-2r}}{\mu\eta} + \frac{1 - \mu}{\mu}}$$

External (detection) losses can be completely overcome!

$$\sim \frac{1}{\langle N \rangle}$$

A.M. Marino, N. V. Corzo Trejo, and P. D. Lett, *PRA* 86, 023844 (2012);
 F. Hudelist, J. Kong, C. Liu, J. Jing, Z.Y. Ou, and W. Zhang, *Nature Comm.* 5:3049 (2014)

OUR SCHEME: NO SEEDING, DIRECT DETECTION

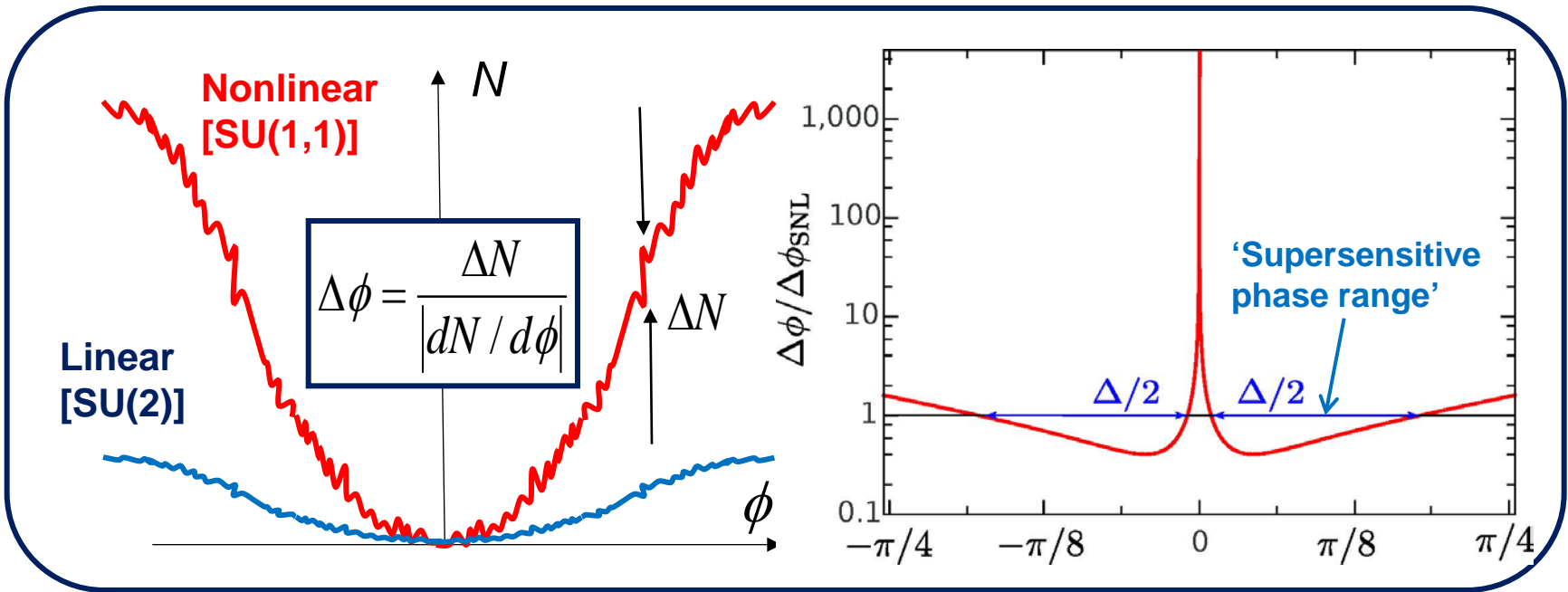
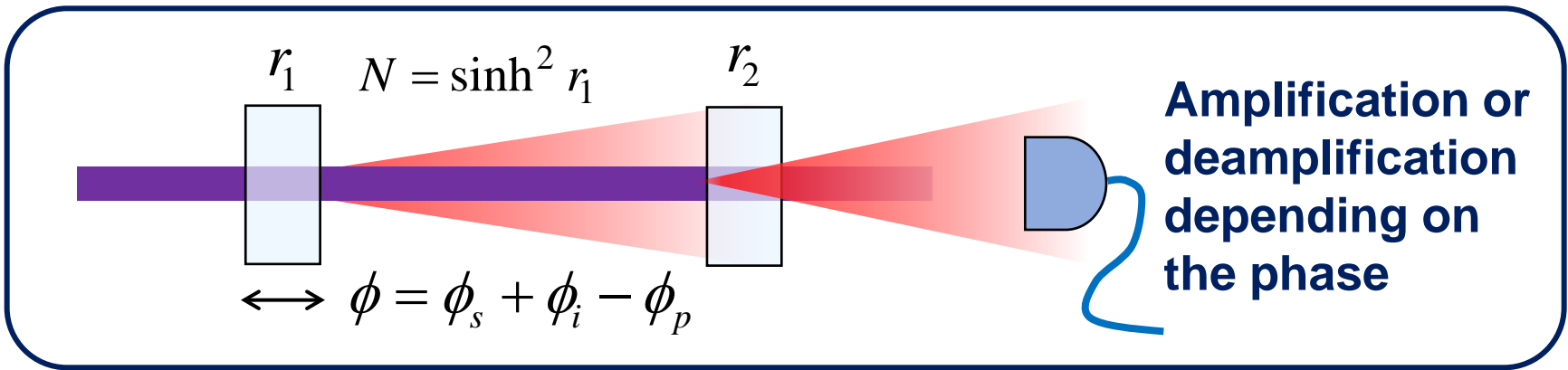

F. Hudelist et al., Nature Comm. 5:3049 (2014).

M. Manceau, F. Khalili, and M. V. Chekhova, NJP 19, 013014 (2017).

MAIN IDEA: GAIN UNBALANCING

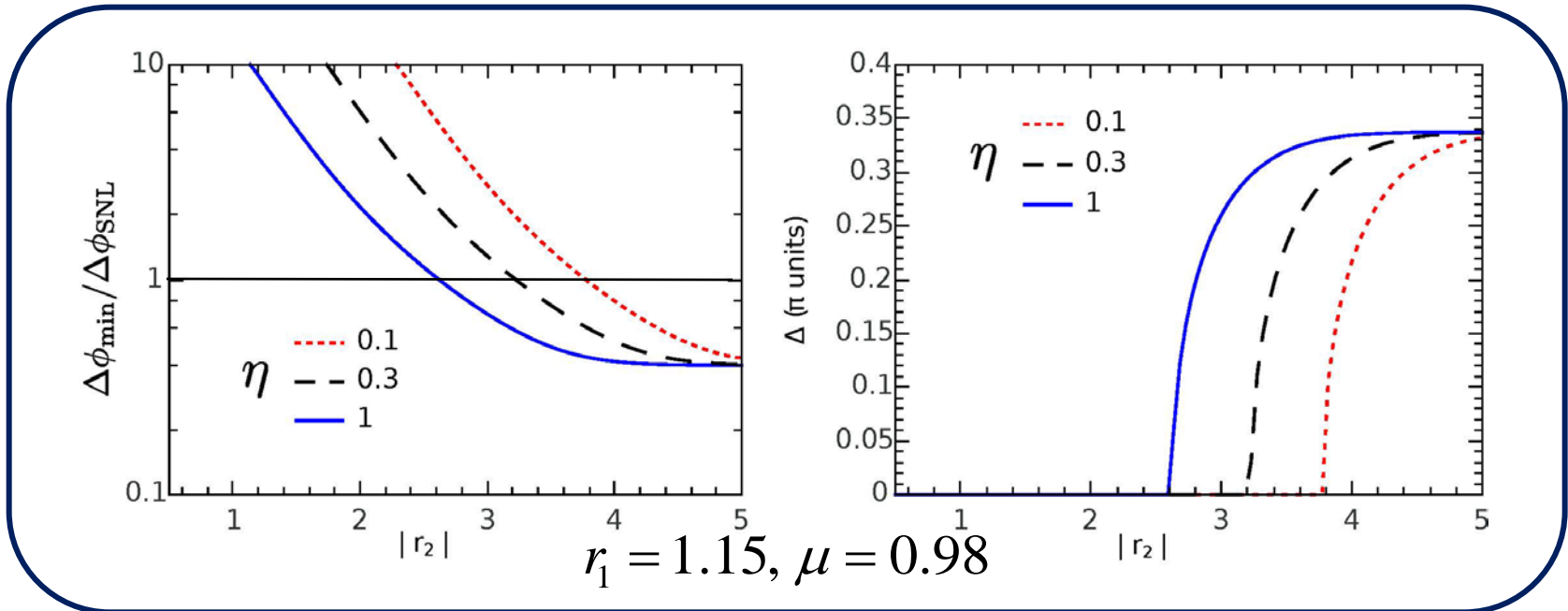
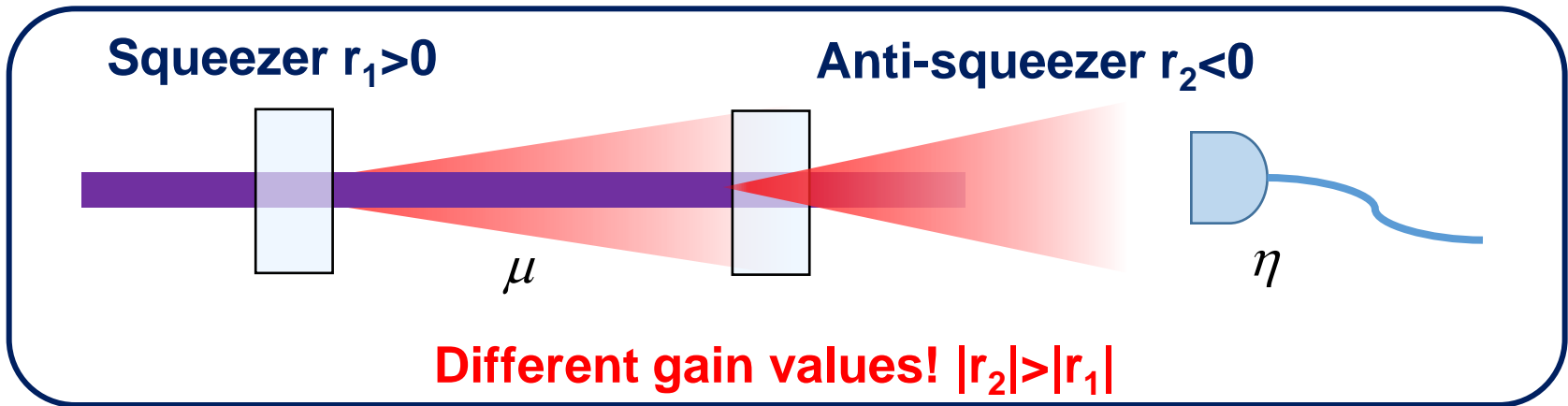

HOW IT WORKS

Squeezer $\phi = \phi_s + \phi_i - \phi_p$ Anti-squeezer

Amplification or deamplification depending on the phase

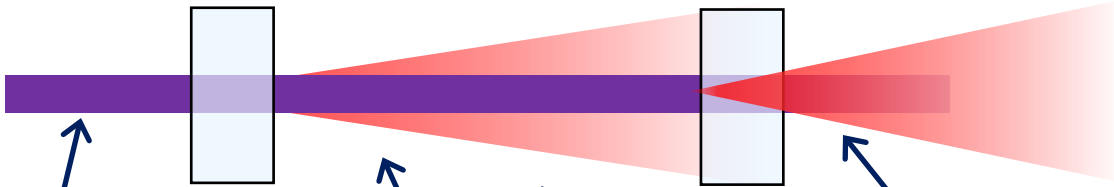

N

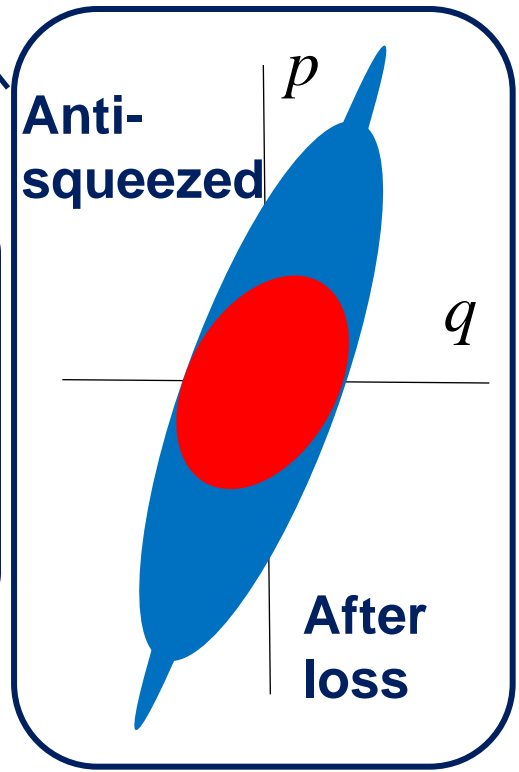
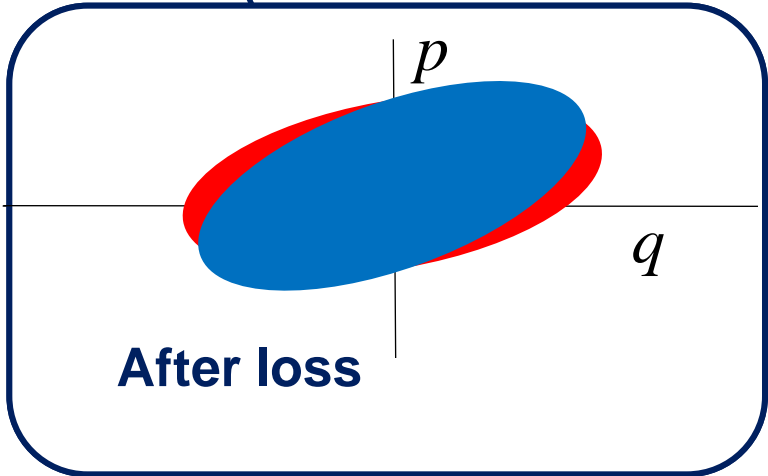
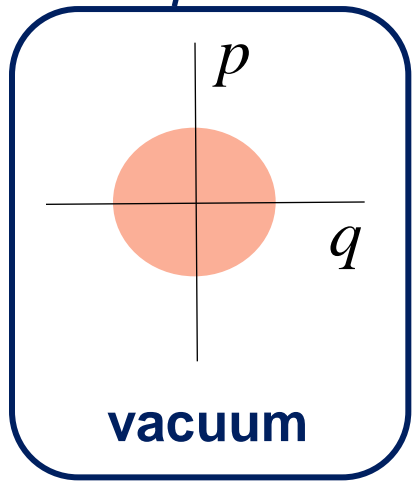

HOW IT WORKS

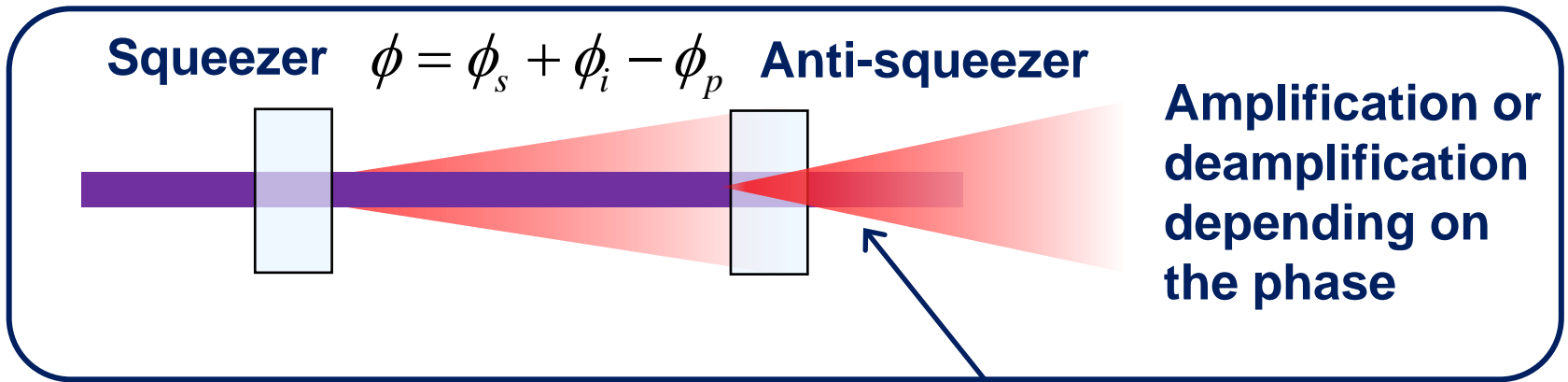

The quadrature responsible for the phase information is amplified before loss and therefore 'protected'

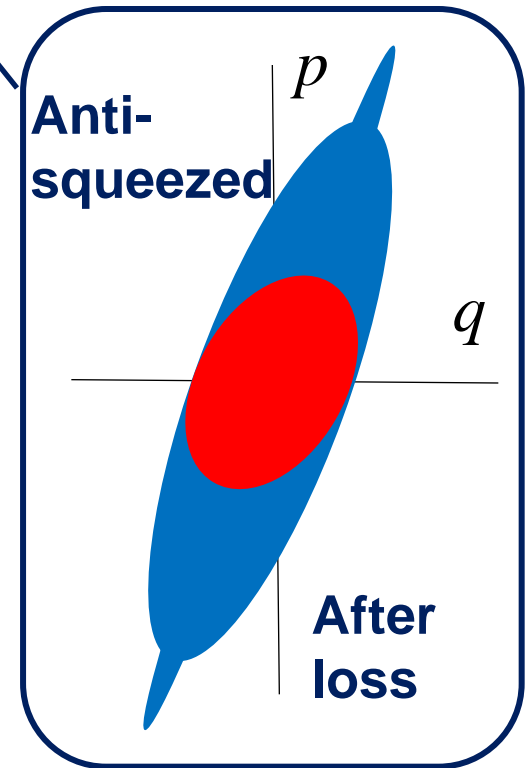

EXPERIMENTAL SETUP

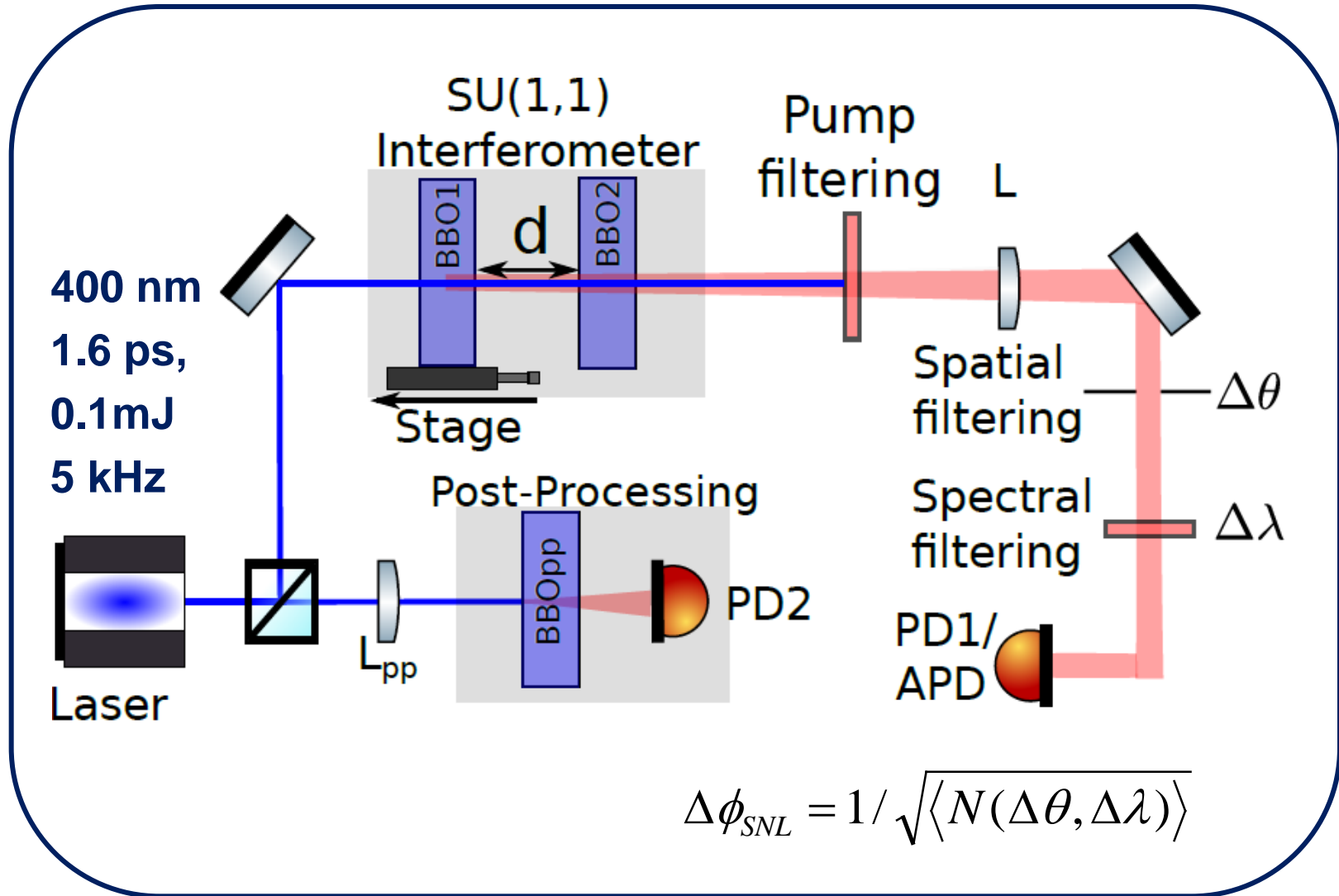

INTERFERENCE FRINGES

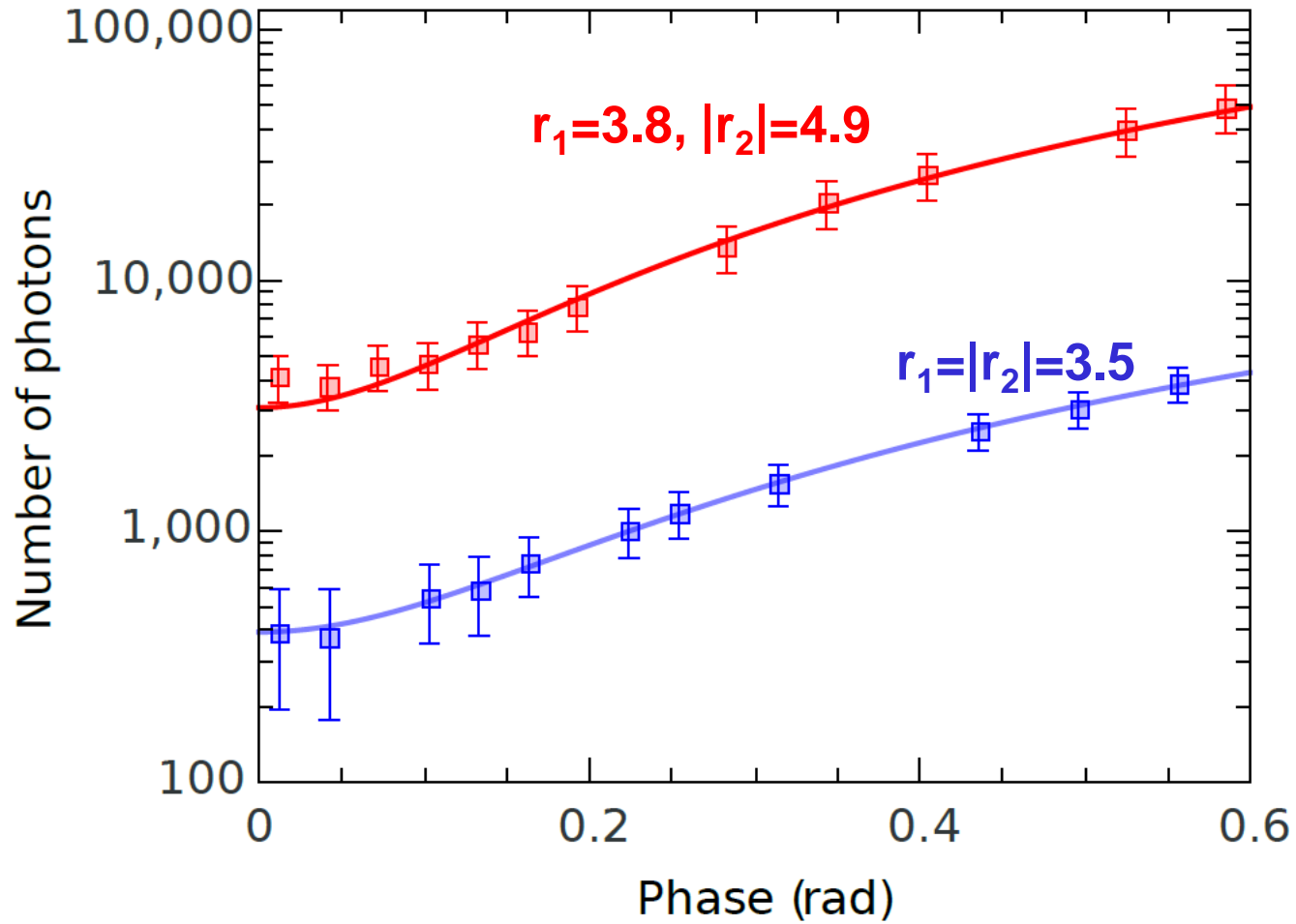

SUPER-SENSITIVE PHASE MEASUREMENTS

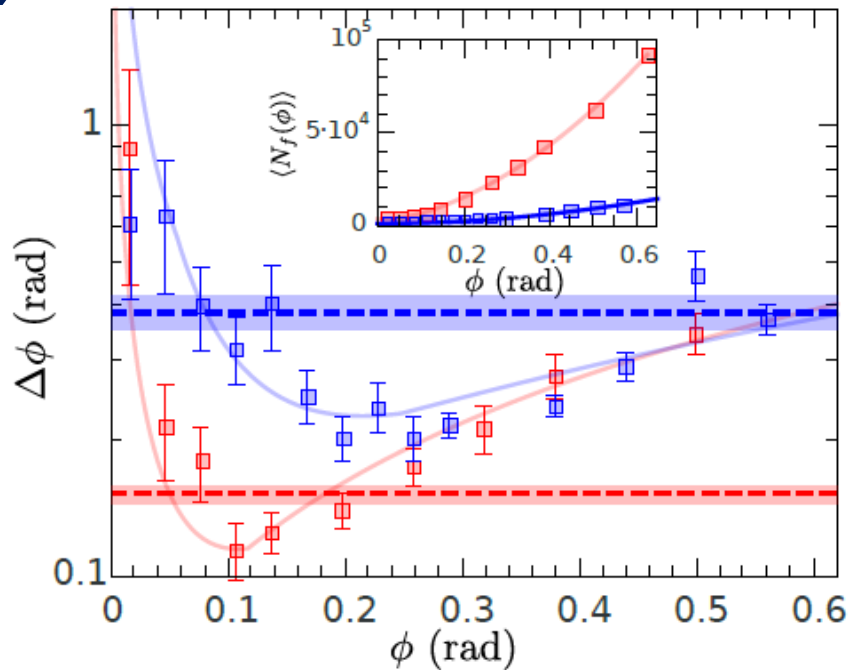

$r_1=1.5, N=1.7, |r_2|=5$

$r_1=2.7, N=11, |r_2|=5$

THE EFFECT OF LOSS

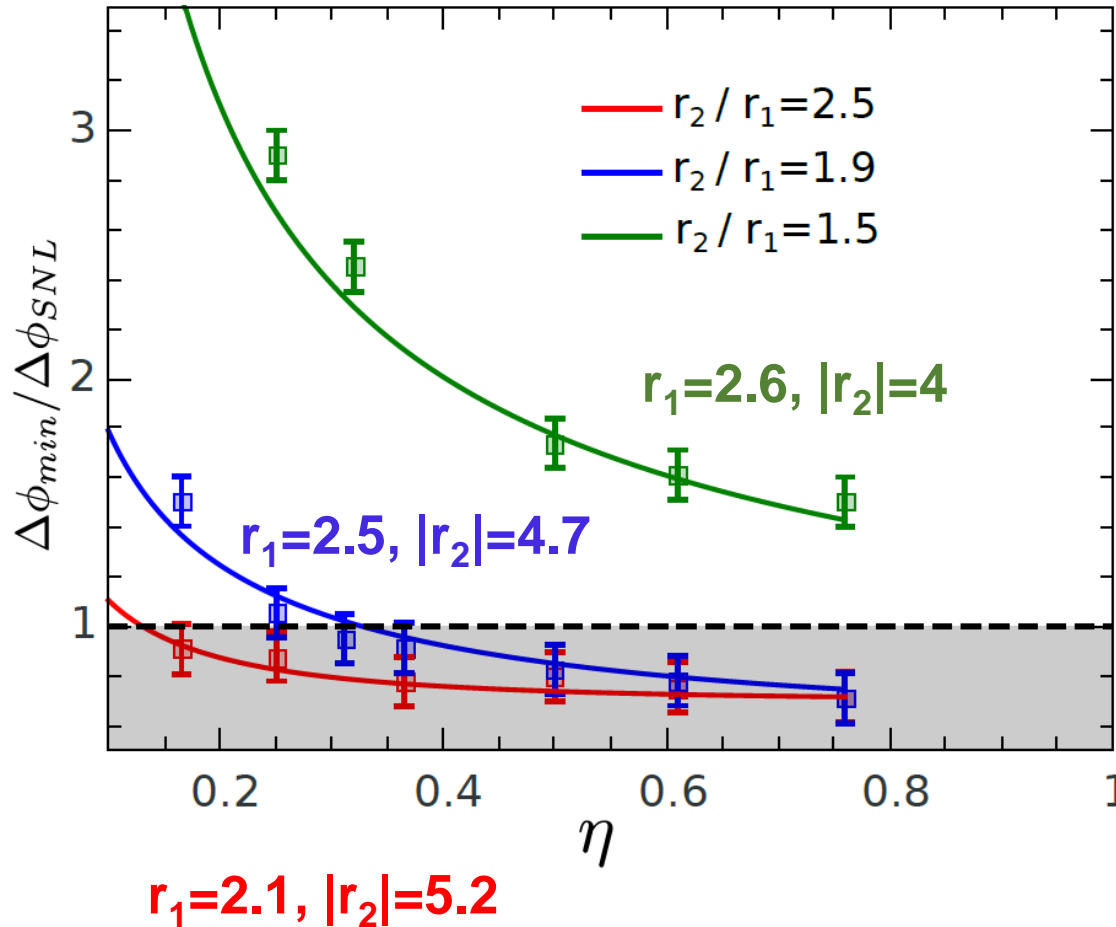

A MORE PRACTICAL SETUP

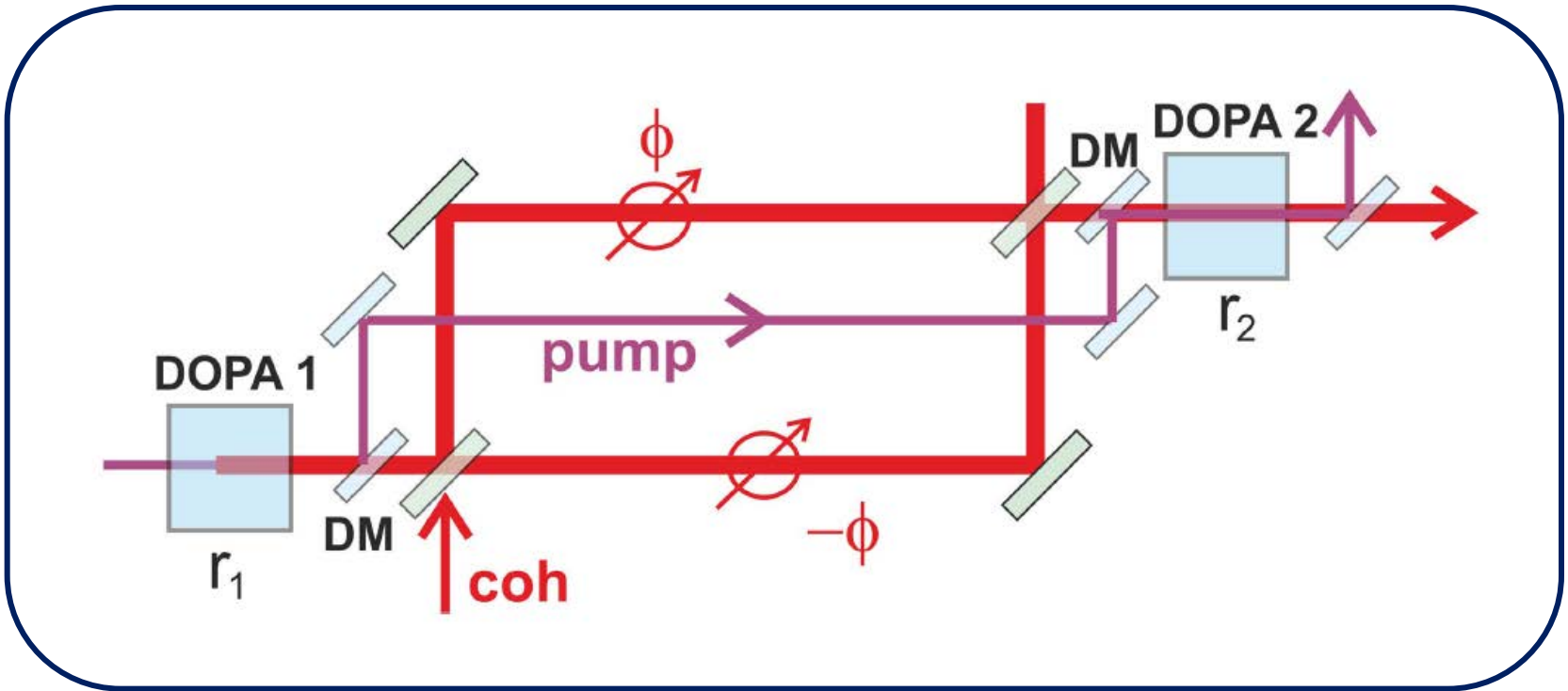

SU(2) interferometer preceded by a squeezer and followed by an anti-squeezer: unbalanced configuration leads to the same advantages

CONCLUSIONS

SU(1,1) interferometer with no seeding and direct detection; **the effect of gain unbalancing.**

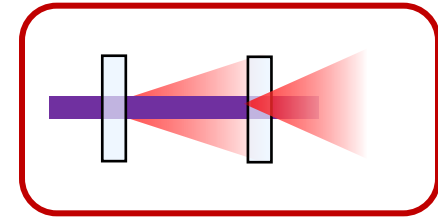

Phase sensitivity 2.3 dB below SNL

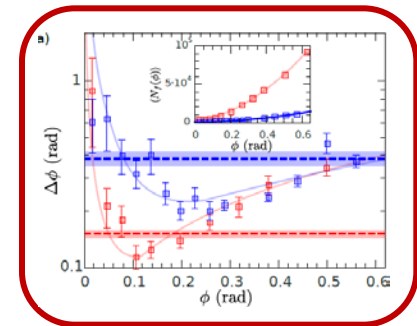

Phase supersensitivity for up to 11 photons, tolerant to losses (QE as low as 17%)

The same “unbalancing” strategy for SU(2) with OPAs placed before and after it

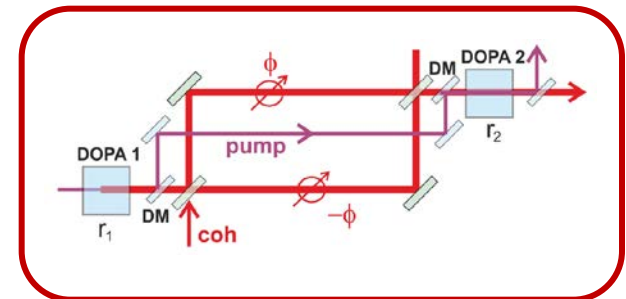

THANK YOU FOR YOUR ATTENTION!

BRIGHT SQUEEZED VACUUM

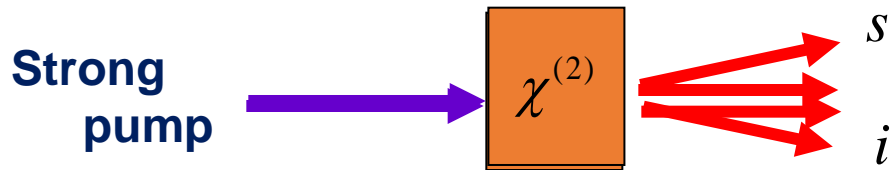

Quadratic squeezing BS

$$\langle \hat{N} \rangle = \langle a^+ a \rangle = \sinh^2(G) \gg 1$$

$$\text{Up to } G \sim 20, \langle \hat{N} \rangle \sim 10^{18}$$

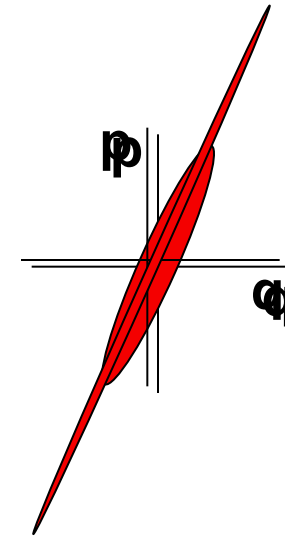

**Nonclassicality: 7.8 dB photon-number squeezing
(observed in the non-degenerate regime)**