

Geometric Aspects of Indistinguishability Operators

J. Recasens

Universitat Politècnica de Catalunya

t-norm

Definition. A *continuous t-norm* is a map $T : [0, 1] \times [0, 1] \rightarrow [0, 1]$ such that for all $x, y, z \in [0, 1]$ satisfies

1. $T(T(x, y), z) = T(x, T(y, z))$ (*Associativity*)
2. $T(x, y) = T(y, x)$ (*Commutativity*)
3. $T(1, x) = x$
4. T is a non-decreasing map
5. T is a continuous map.

NB. Commutativity can be derived from the other properties though the proof is not trivial.

Most Important t-norms

Example.

1. The *minimum* t-norm \min defined by $\min(x, y)$ for all $x, y \in [0, 1]$.
2. The t-norm of *Lukasiewicz* defined by $T(x, y) = \max(0, x + y - 1)$.
3. The *Product* t-norm $T(x, y) = x \cdot y$.

It is trivial to prove that the minimum t-norm is the greatest t-norm.

Archimedean t-norms

Definition. For a t-norm T $x \in [0, 1]$ is an *idempotent element* if and only if $T(x, x) = x$. $E(T)$ will be the set of idempotent elements of T .

Definition. A t-norm T is *Archimedean* if and only if $E(T) = \{0, 1\}$.

Example. The t-norms Product and Łukasiewicz are Archimedean t-norms, while the minimum t-norm is not.

Definition. For a t-norm T , $x \in [0, 1]$ is *nilpotent* if and only if there exists $n \in \mathbb{N}$ such that $T^n(x) = 0$. $Nil(T)$ will be the set of nilpotent elements of T .

(T^n is defined recursively: $T^n(x) = T(T^{n-1}(x), x)$).

Theorem. If a t-norm T is continuous Archimedean, then $Nil(T)$ is $[0, 1)$ or $\{0\}$. In the first case, T is called *non-strict Archimedean*. In the second case, T is called *strict Archimedean*.

Isomorphic t-norms

Definition. Two t-norms T, T' are *isomorphic* if and only if there exists a bijective map $f : [0, 1] \rightarrow [0, 1]$ such that

$$(f \circ T)(x, y) = T'(f(x), f(y))$$

Theorem.

- All continuous strict Archimedean t-norms are isomorphic to the Product t-norm.
- All continuous non-strict Archimedean t-norms are isomorphic to the t-norm of Łukasiewicz.

Ling's Theorem

Theorem. *Ling's Theorem*

A continuous t-norm T is Archimedean if and only if there exists a continuous and strictly decreasing function $t : [0, 1] \rightarrow [0, \infty)$ with $t(1) = 0$ such that

$$T(x, y) = t^{[-1]}(t(x) + t(y))$$

*where $t^{[-1]}$ is the **pseudo inverse** of t , defined by*

$$t^{[-1]}(x) = \begin{cases} t^{-1}(x) & \text{if } x \in [0, t(0)] \\ 0 & \text{otherwise.} \end{cases}$$

*T is strict if $t(0) = \infty$ and non-strict otherwise. t is called an **additive generator** of T and two generators of the same t-norm differ only by a positive multiplicative constant.*

Ordinal Sums

Example.

1. $t(x) = 1 - x$ is an additive generator of the t -norm of Łukasiewicz.
2. $t(x) = -\log(x)$ is an additive generator of the Product t -norm.

Theorem. Given a continuous t -norm T there exists a set of at most denombrable disjoint open intervals (a_i, b_i) such that in every set $[a_i, b_i] \times [a_i, b_i]$ the t -norm is a reduced copy T_i of an Archimedean t -norm and outside these sets the t -norm coincides with the minimum one. T is then called an **ordinal sum** of T_i .

Indistinguishability Operator

Definition. Let X be a universe and T a t -norm. A T -indistinguishability operator E on X is fuzzy relation $E : X \times X \rightarrow [0, 1]$ on X satisfying for all $x, y, z \in X$

1. $E(x, x) = 1$ (*Reflexivity*)
2. $E(x, y) = E(y, x)$ (*Symmetry*)
3. $T(E(x, y), E(y, z)) \leq E(x, z)$ (*T -Transitivity*)

E separates points if and only if $E(x, y) = 1$ implies $x = y$.

$E(x, y)$ is interpreted as the degree of indistinguishability (or similarity) between x and y .

Generation of Indistinguishability Operators

One of the most interesting issues related to indistinguishability operators is their generation, which depends on the way in which the data are given and the use we want to make of them. The four most common ways are:

- By calculating the T -transitive closure of a reflexive and symmetric fuzzy relation (a proximity or tolerance relation).
- By using the Representation Theorem.
- By calculating a decomposable operator from a fuzzy subset.
- By obtaining a transitive opening of a proximity relation.

Transitive Closure

Given a t-norm T , the **transitive closure** of a reflexive and symmetric fuzzy relation R on a set X is the smallest T -indistinguishability operator relation \overline{R} on X greater than or equal to R .

The Crisp Case

In the crisp case, if R is represented by a graph, its transitive closure is the smallest graph that contains R and with all its connected components complete subgraphs. This produces the well known chain effect or **chaining**.

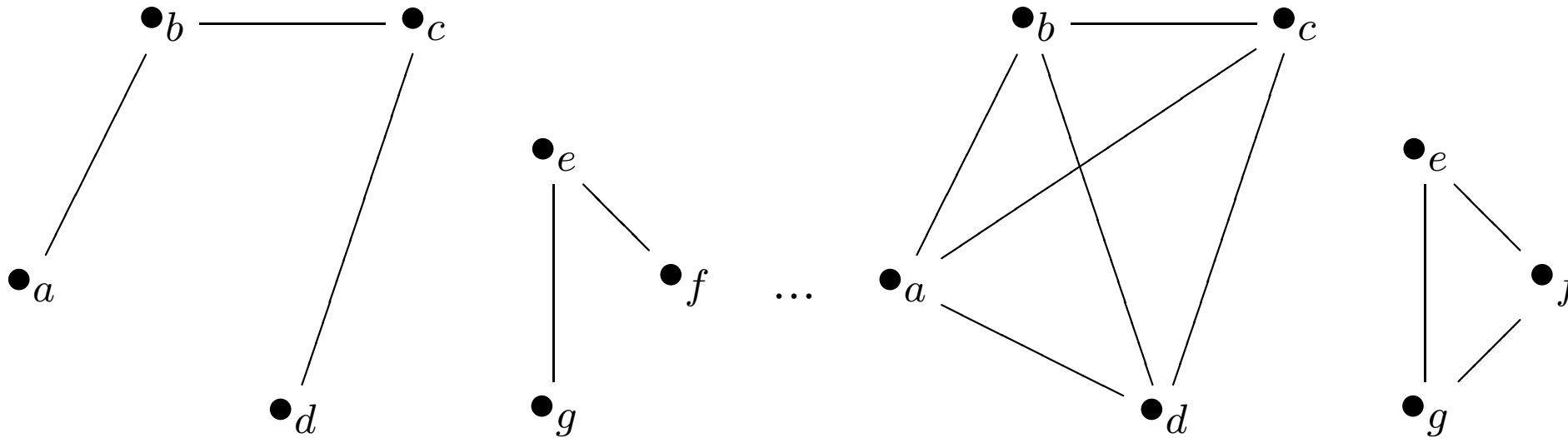

sup –T Product

Definition. Let R and S be two fuzzy relations on X and T a t-norm. The **sup –T product** of R and S is the fuzzy relation $R \circ S$ on X defined for all $x, y \in X$ by

$$(R \circ S)(x, y) = \sup_{z \in X} T(R(x, z), S(z, y)).$$

The n^{th} **power** R^n of a fuzzy relation R is

$$R^n = \overbrace{R \circ \dots \circ R}^{n \text{ times}}.$$

The crisp case:

xR^2y if and only if $\exists z$ such that xRz and zRy .

Graphs of R and R^2

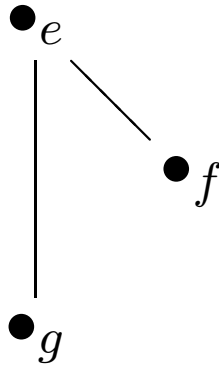
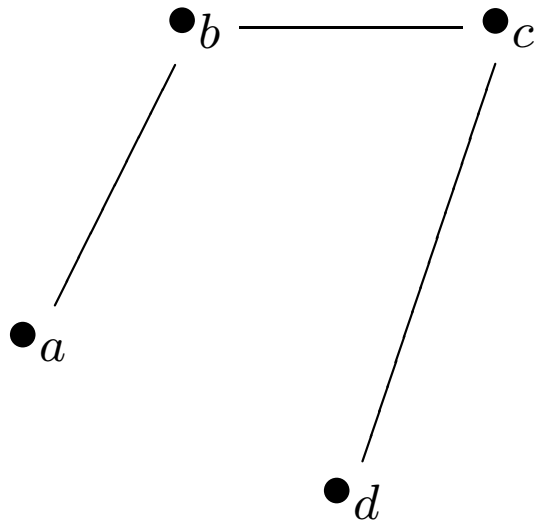

...

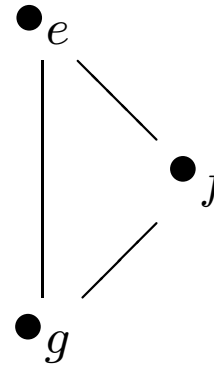
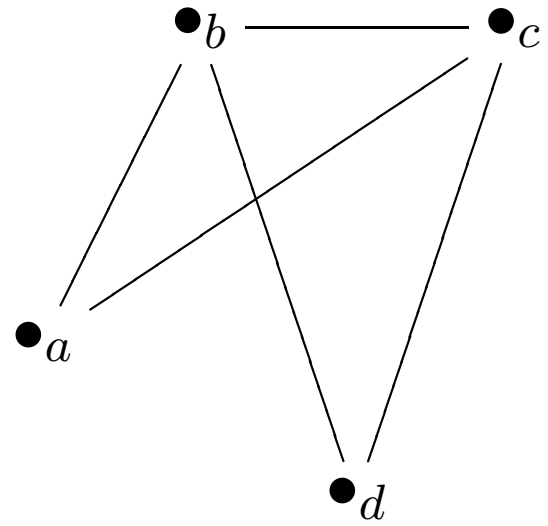

Transitive Closure and \sup – T Product

Theorem. *Let R be a reflexive and symmetric fuzzy relation on a set X and T a continuous t -norm. Then the fuzzy relation $\sup_{n \in \mathbb{N}} R^n$ on X is the T -transitive closure of R .*

Proposition. *The transitive closure of a reflexive and symmetric fuzzy relation R is the intersection of all T -indistinguishability operators greater than or equal to R .*

The Representation Theorem

Definition. The *residuation* \overrightarrow{T} of a t -norm T is the map $\overrightarrow{T} : [0, 1] \times [0, 1] \rightarrow [0, 1]$ defined for all $x, y \in [0, 1]$ by

$$\overrightarrow{T}(x|y) = \sup\{\alpha \in [0, 1] \mid T(x, \alpha) \leq y\}.$$

Definition. The *biresiduation* \overleftrightarrow{T} of a t -norm T is the map $\overleftrightarrow{T} : [0, 1] \times [0, 1] \rightarrow [0, 1]$ defined for all $x, y \in [0, 1]$ by

$$\overleftrightarrow{T}(x, y) = T(\overrightarrow{T}(x|y), \overrightarrow{T}(y|x)) = \min(\overrightarrow{T}(x|y), \overrightarrow{T}(y|x)).$$

The biresiduation is also known as the **natural T -indistinguishability operator** associated to T and is also notated by E_T .

- If T is a continuous Archimedean t-norm with additive generator t , then

$$E_T(x, y) = t^{-1}(|t(x) - t(y)|) \text{ for all } x, y \in [0, 1].$$

As special cases,

- If T is the Łukasiewicz t-norm, then

$$E_T(x, y) = \overset{\leftrightarrow}{T}(x, y) = 1 - |x - y| \text{ for all } x, y \in [0, 1].$$

- If T is the Product t-norm, then

$$E_T(x, y) = \overset{\leftrightarrow}{T}(x, y) = \min\left(\frac{x}{y}, \frac{y}{x}\right) \text{ for all } x, y \in [0, 1] \text{ where } \frac{z}{0} = 1.$$

- If T is the minimum t-norm, then

$$E_T(x, y) = \overset{\leftrightarrow}{T}(x, y) = \begin{cases} \min(x, y) & \text{if } x \neq y \\ 1 & \text{otherwise.} \end{cases}$$

$$E_\mu$$

Proposition. *Let μ be a fuzzy subset of X and T a continuous t -norm. The fuzzy relation E_μ on X defined for all $x, y \in X$ by*

$$E_\mu(x, y) = E_T(\mu(x), \mu(y))$$

is a T -indistinguishability operator.

In the crisp case, when $\mu = A$ is a crisp subset of X , E_A generates a partition of X into A and its complementary set $X - A$, since in this case $E_A(x, y) = 1$ if and only if x and y both belong to A or to $X - A$.

Lemma. Let $(E_i)_{i \in I}$ be a family of T -indistinguishability operators on a set X . The relation E on X defined for all $x, y \in X$ by

$$E(x, y) = \inf_{i \in I} E_i(x, y)$$

is a T -indistinguishability operator.

Representation Theorem

Theorem. *Representation Theorem.* Let R be a fuzzy relation on a set X and T a continuous t -norm. R is a T -indistinguishability operator if and only if there exists a family $(\mu_i)_{i \in I}$ of fuzzy subsets of X such that for all $x, y \in X$

$$R(x, y) = \inf_{i \in I} E_{\mu_i}(x, y).$$

$(\mu_i)_{i \in I}$ is called a **generating family** of R . A fuzzy subset belonging to a generating family of R is called a **generator** of R . A generating family of R with minimal cardinality is called a **basis** of E and the cardinality of the corresponding set of indexes its **dimension**.

Lemma. μ is a generator of E if and only if $E_{\mu} \geq E$.

Generalization to T -transitive Fuzzy Relations

Theorem. *Let R be a fuzzy relation on a set X and T a continuous t -norm. R is T -transitive if and only if there exist two families $(\mu_i)_{i \in I}$ and $(\nu_i)_{i \in I}$ of fuzzy subsets of X with $\mu_i \geq \nu_i \forall i \in I$ such that for all $x, y \in X$*

$$R(x, y) = \inf_{i \in I} \overrightarrow{T}(\mu_i(x) | \nu_i(y)).$$

Decomposable Indistinguishability Operators

Definition. Let T be a t -norm. The *decomposable* T -indistinguishability operator E^μ generated by a fuzzy subset μ of X is defined for all $x, y \in X$ by

$$E^\mu(x, y) = \begin{cases} T(\mu(x), \mu(y)) & \text{if } x \neq y \\ 1 & \text{otherwise.} \end{cases}$$

Tetrahedric relation

Proposition. *Let T be a continuous Archimedean t -norm with additive generator t and μ a fuzzy subset of X . If the decomposable T -indistinguishability operator E^μ on X generated by μ satisfies $E^\mu(x, y) \neq 0$ for all $x, y \in X$, then it generates the following tetrahedric relation on X : Given four different elements $x, y, z, t \in X$,*

$$T(E^\mu(x, y), E^\mu(z, t)) = T(E^\mu(x, z), E^\mu(y, t)).$$

Transitive Openings

Definition. Let R be a proximity relation on a set X and T a t -norm. A T -indistinguishability operator \underline{R} on X is a T -transitive opening of R if and only if

- $\underline{R} \leq R$
- If E is another T -indistinguishability operator on X satisfying $E \leq R$, then $E \leq \underline{R}$.

Complete linkage

In the **complete linkage**, the entries of a proximity relation $R = (a_{ij})$ on a finite set X are modified according to the next algorithm to obtain a min-transitive opening. Given two disjoint subsets C_i, C_j of X its similarity degree S is defined by $S(C_i, C_j) = \min_{i \in C_i, j \in C_j} (a_{ij})$.

1. Initially a cluster C_i is assigned to every element x_i of X (i.e. the clusters of the first partition are singletons).
2. In each new step two clusters are merged in the following way. If $\{C_1, C_2, \dots, C_k\}$ is the actual partition, then we must select the two clusters C_i and C_j for which the similarity degree $S(C_i, C_j)$ is maximal. (If there are several such maximal pairs, one pair is picked at random). The new cluster $C_i \cup C_j$ replaces the two clusters C_i and C_j , and all entries of a_{mn} and a_{nm} of R with $m \in C_i$ and $n \in C_j$ are lowered to $S(C_i, C_j)$.
3. Step 2 is repeated until there remains one single cluster containing all the elements of X .

Example. Let us consider the proximity R on $X = \{x_1, x_2, x_3, x_4\}$ with matrix

$$\begin{array}{c} \\ x_1 \\ x_2 \\ x_3 \\ x_4 \end{array} \begin{array}{cccc} x_1 & x_2 & x_3 & x_4 \\ \left(\begin{array}{cccc} 1 & 0.1 & 0.7 & 0.4 \\ 0.1 & 1 & 0.4 & 0.3 \\ 0.7 & 0.4 & 1 & 0.5 \\ 0.4 & 0.3 & 0.5 & 1 \end{array} \right) \end{array}.$$

The first partition is $C_1 = \{x_1\}$, $C_2 = \{x_2\}$, $C_3 = \{x_3\}$, $C_4 = \{x_4\}$. The greatest similarity degree between clusters is $S(C_1, C_3) = 0.7$. These two clusters are merged to form $C_{13} = \{x_1, x_3\}$. The matrix does not change in this step.

The new partition is C_{13} , C_2 , C_4 . The similarity degrees are

$$S(C_{13}, C_2) = \min(a_{12}, a_{32}) = \min(0.1, 0.4) = 0.1$$

$$S(C_{13}, C_4) = \min(a_{14}, a_{34}) = \min(0.4, 0.5) = 0.4$$

$$S(C_2, C_4) = a_{24} = 0.3.$$

The greatest similarity degree is 0.4 and the new partition is therefore $C_{134} = \{x_1, x_3, x_4\}$, $C_2 = \{x_2\}$.

The entries a_{14} , a_{41} , a_{34} , a_{43} of the matrix R are replaced by 0.4 obtaining

$$\begin{matrix} & x_1 & x_2 & x_3 & x_4 \\ x_1 & \left(\begin{matrix} 1 & 0.1 & 0.7 & 0.4 \\ 0.1 & 1 & 0.4 & 0.3 \\ 0.7 & 0.4 & 1 & 0.4 \\ 0.4 & 0.3 & 0.4 & 1 \end{matrix} \right) \\ x_2 & \\ x_3 & \\ x_4 & \end{matrix} \cdot$$

In the last step, we merge the two clusters C_{134} , C_2 . The similarity degree is

$$S(C_{134}, C_2) = \min(a_{12}, a_{32}, a_{42}) = \min(0.1, 0.4, 0.3) = 0.1.$$

The transitive opening of R obtained by complete linkage is then

$$\begin{matrix} & x_1 & x_2 & x_3 & x_4 \\ x_1 & \left(\begin{matrix} 1 & 0.1 & 0.7 & 0.4 \\ 0.1 & 1 & 0.1 & 0.1 \\ 0.7 & 0.1 & 1 & 0.4 \\ 0.4 & 0.1 & 0.4 & 1 \end{matrix} \right) \\ x_2 & \\ x_3 & \\ x_4 & \end{matrix} \cdot$$

The Archimedean case

Proposition. *Let R be a proximity relation on a finite set $X = \{r_1, r_2, \dots, r_s\}$ of cardinality s and T a t -norm. S is a T -indistinguishability operator smaller than or equal to R if and only if its entries satisfy the following system of inequalities:*

$$0 \leq S(r_i, r_j) \leq R(r_i, r_j)$$

for all $i, j = 1, 2, \dots, s$.

$$T(S(r_i, r_j), S(r_j, r_k)) \leq S(r_i, r_k)$$

for all $i, j, k = 1, 2, \dots, s$.

$$S(r_i, r_j) = S(r_j, r_i)$$

for all $i, j = 1, 2, \dots, s$.

Example. Let us consider the reflexive and symmetric fuzzy relation $R = \begin{pmatrix} 1 & \frac{2}{3} & 0 \\ \frac{2}{3} & 1 & \frac{2}{3} \\ 0 & \frac{2}{3} & 1 \end{pmatrix}$ on

$X = \{a, b, c\}$. A fuzzy relation S on X with matrix $S = \begin{pmatrix} 1 & p & q \\ p & 1 & r \\ q & r & 1 \end{pmatrix}$ is an L -indistinguishability

operator smaller than or equal to R if and only if

$$0 \leq p \leq \frac{2}{3} \quad T(q, p) \leq r$$

$$0 \leq q \leq 0 \quad T(q, r) \leq p$$

$$0 \leq r \leq \frac{2}{3} \quad T(r, p) \leq q$$

$$T(p, q) \leq r \quad T(r, q) \leq p$$

$$T(p, r) \leq q.$$

If T is the t-norm of Łukasiewicz, then there are 8 possible solutions:

$$p = 0, \frac{1}{3}, \quad q = 0, \quad r = 0, \frac{1}{3}, \frac{2}{3}$$
$$p = \frac{2}{3}, \quad q = 0, \quad r = 0, \frac{1}{3}.$$

Among them, there are 2 L -transitive openings of R . Namely

$$\begin{pmatrix} 1 & \frac{1}{3} & 0 \\ \frac{1}{3} & 1 & \frac{2}{3} \\ 0 & \frac{2}{3} & 1 \end{pmatrix}, \quad \begin{pmatrix} 1 & \frac{2}{3} & 0 \\ \frac{2}{3} & 1 & \frac{1}{3} \\ 0 & \frac{1}{3} & 1 \end{pmatrix}.$$

Granularity and Extensional Sets

- Extensional fuzzy subsets
- Upper approximations
- Lower approximations
- Fuzzy Points

Granularity

According to *L.A. Zadeh*, *granularity* is one of the basic concepts that underlie human cognition and the elements within a granule '*have to be dealt with as a whole rather than individually*'.

Informally, granulation of an object A results in a collection of granules of A, with a granule being a clump of objects (or points) which are drawn together by indistinguishability, similarity, proximity or functionality.

L.A. Zadeh

Extensional Fuzzy Subsets

Definition. Let E be a T -indistinguishability operator on a set X . A fuzzy subset μ of X is *extensional* with respect to E (or simply *extensional*) if and only if for all $x, y \in X$

$$T(E(x, y), \mu(y)) \leq \mu(x).$$

H_E will be the set of extensional fuzzy subsets of X with respect to E .

This definition fuzzifies the predicate

If x and y are equivalent and $y \in \mu$, then $x \in \mu$.

Proposition. Let E be a T -indistinguishability operator on X , μ a fuzzy subset of X and E_μ the T -indistinguishability operator generated by μ . $\mu \in H_E$ if and only if $E_\mu \geq E$.

Hence H_E coincides with the set of generators of E .

Lemma. Given a T -indistinguishability operator E on a set X and an element $x \in X$, the **column** $\mu_x = E(x, \cdot)$ of x is extensional.

Proposition. Let E be a T -indistinguishability operator on a set X . The following properties are satisfied for all $\mu \in H_E$, $(\mu_i)_{i \in I}$ a family of extensional fuzzy subsets and $\alpha \in [0, 1]$.

1. $\bigvee_{i \in I} \mu_i \in H_E$.
2. $\bigwedge_{i \in I} \mu_i \in H_E$.
3. $T(\alpha, \mu) \in H_E$.
4. $\overrightarrow{T}(\mu|\alpha) \in H_E$.
5. $\overrightarrow{T}(\alpha|\mu) \in H_E$.

Theorem. Let H be a subset of $[0, 1]^X$ satisfying the properties of the last proposition. Then there exists a T -indistinguishability operator E on X such that $H = H_E$. E is uniquely determined and it is generated (using the Representation Theorem) by the family of elements of H .

Upper and Lower Approximations

Upper and Lower Approximations

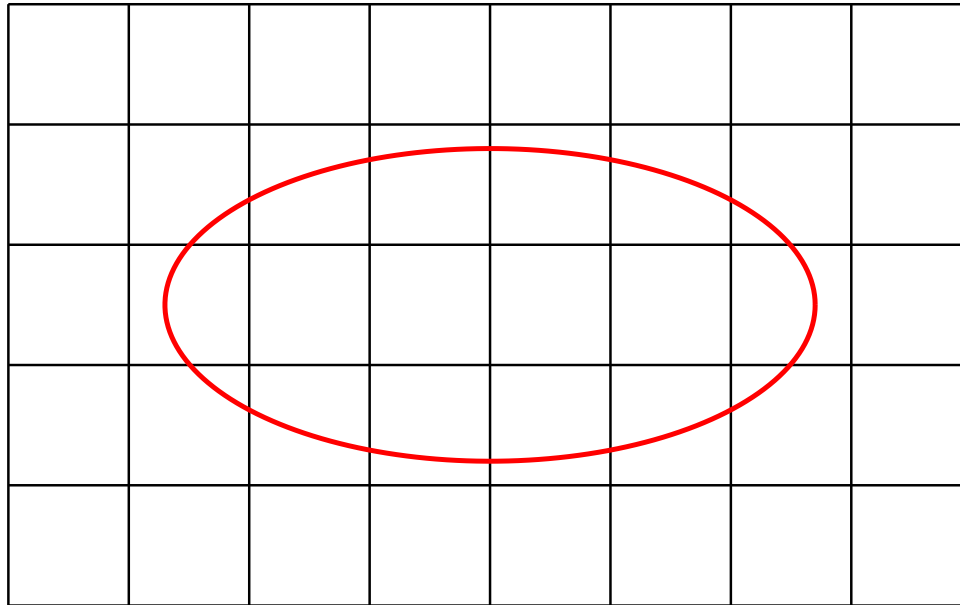

Upper and Lower Approximations

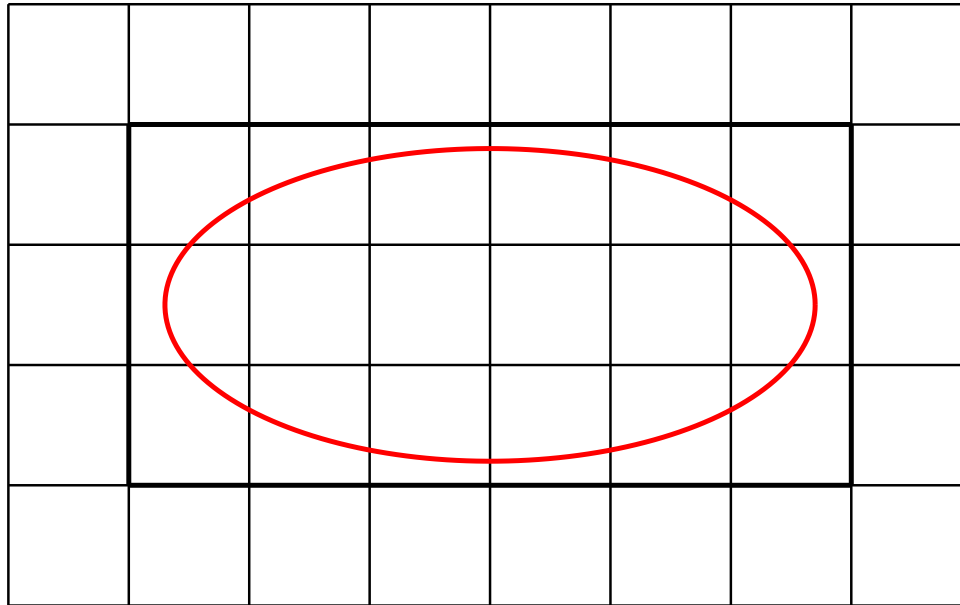

Upper and Lower Approximations

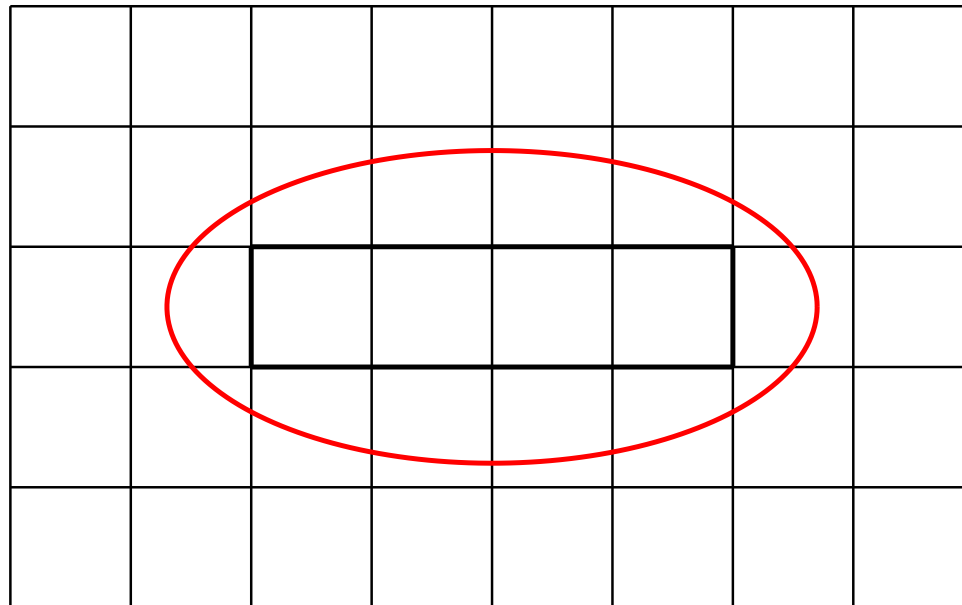

The Map ϕ_E

Definition. Let E be a T -indistinguishability operator on a set X . The map $\phi_E : [0, 1]^X \rightarrow [0, 1]^X$ is defined for all $x \in X$ by

$$\phi_E(\mu)(x) = \sup_{y \in X} T(E(x, y), \mu(y)).$$

Proposition. For all $\mu, \mu' \in [0, 1]^X$,

1. If $\mu \leq \mu'$ then $\phi_E(\mu) \leq \phi_E(\mu')$.
2. $\mu \leq \phi_E(\mu)$.
3. $\phi_E(\bigvee_{i \in I} \mu_i) = \bigvee_{i \in I} \phi_E(\mu_i)$.
4. $\phi_E(\phi_E(\mu)) = \phi_E(\mu)$.
5. $\phi_E(\{x\})(y) = \phi_E(\{y\})(x)$
6. $\phi_E(T(\alpha, \mu)) = T(\alpha, \phi_E(\mu))$.

Theorem. Let $\phi : [0, 1]^X \rightarrow [0, 1]^X$ be a map satisfying the properties of the last proposition. The fuzzy relation E_ϕ on X defined for all $x, y \in X$ by

$$E_\phi(x, y) = \phi(\{x\})(y)$$

is a T -indistinguishability operator on X .

Proposition. $\mu \in H_E$ if and only if $\phi_E(\mu) = \mu$.

Hence, H_E is characterized as the set of fixed points of ϕ_E .

Proposition. $\text{Im}(\phi_E) = H_E$.

Proposition. For any $\mu \in [0, 1]^X$, $\phi_E(\mu) = \inf_{\mu' \in H_E} \{\mu \leq \mu'\}$.

So, $\phi_E(\mu)$ is the most specific extensional set that contains μ (i.e. $\mu \leq \phi_E(\mu)$) and in this sense it is the optimal **upper approximation** of μ in H_E .

The Map ψ_E

Definition. Let E be a T -indistinguishability operator on a set X . The map $\psi_E : [0, 1]^X \rightarrow [0, 1]^X$ is defined by

$$\psi_E(\mu)(x) = \inf_{y \in X} \overrightarrow{T}(E(x, y) | \mu(y)) \quad \forall x \in X.$$

Proposition. For all $\mu, \mu' \in [0, 1]^X$, we have:

1. $\mu \leq \mu' \Rightarrow \psi_E(\mu) \leq \psi_E(\mu')$.
2. $\psi_E(\mu) \leq \mu$.
3. $\psi_E(\bigwedge_{i \in I} \mu_i) = \bigwedge_{i \in I} \psi_E(\mu_i)$.
4. $\psi_E(\psi_E(\mu)) = \psi_E(\mu)$.
5. $\psi_E(\overrightarrow{T}(\{x\}|\alpha))(y) = \psi_E(\overrightarrow{T}(\{y\}|\alpha))(x)$.
6. $\psi_E(\overrightarrow{T}(\alpha|\mu)) = \overrightarrow{T}(\alpha|\psi_E(\mu))$.

Theorem. Let $\psi : [0, 1]^X \rightarrow [0, 1]^X$ be a map satisfying the properties of the last proposition. The fuzzy relation E_ψ on X defined for all $x, y \in X$ by

$$E_\psi(x, y) = \inf_{\alpha \in [0, 1]} \overrightarrow{T}(\psi(\overrightarrow{T}(\{x\}|\alpha))(y)|\alpha).$$

is a T -indistinguishability operator on X .

Proposition. $\mu \in H_E$ if and only if $\psi_E(\mu) = \mu$.

Hence, H_E is also characterized as the set of fixed points of ψ_E .

Proposition. $\text{Im}(\psi_E) = H_E$.

Proposition. For any $\mu \in [0, 1]^X$, $\psi_E(\mu) = \sup_{\mu' \in H_E} \{\mu' \leq \mu\}$.

So, $\psi_E(\mu)$ is the greatest extensional set contained in μ (i.e. $\mu \geq \phi_E(\mu)$) and in this sense it is the optimal **lower approximation** of μ in H_E .

Fuzzy Points

Definition. Let E be a T -indistinguishability operator on a set X .
 $\mu \in H_E$ is a *fuzzy point* of X with respect to E if and only if

$$T(\mu(x_1), \mu(x_2)) \leq E(x_1, x_2) \quad \forall x_1, x_2 \in X.$$

P_X will denote the set of fuzzy points of X with respect to E .

The Map Λ_E

Definition. Let E be a T -indistinguishability operator on a set X . The map $\Lambda_E : [0, 1]^X \rightarrow [0, 1]^X$ is defined by

$$\Lambda_E(\mu)(x) = \inf_{y \in X} \overrightarrow{T}(\mu(y) | E(y, x)) \quad \forall x \in X.$$

Proposition. *Let μ be a normal fuzzy subset of X (i.e. $\exists x_0 \in X$ such that $\mu(x_0) = 1$) $\Lambda_E(\mu) = \mu$ if and only if μ is a column μ_x of E .*

Proposition. *Let E be a T -indistinguishability operator on X and $\mu \in H_E$. $\Lambda_E(\mu) \geq \mu$ if and only if $\mu \in P_X$.*

Theorem. *Let E be a T -indistinguishability operator on X . $\text{Fix}(\Lambda_E)$ is the set of all fuzzy points $\mu \in P_X$ which are maximal in P_X .*

Fuzzy Points and the Representation Theorem

Proposition. Let $(\mu_i)_{i \in I}$ be a family of fuzzy subsets of X and E the T -indistinguishability operator generated by this family ($E(x, y) = \inf_{i \in I} E_{\mu_i}(x, y)$). Then E is the greatest T -indistinguishability operator for which all the fuzzy subsets of the family are extensional.

Proposition. Let $(\mu_i)_{i \in I}$ be a family of normal fuzzy subsets of X and $(x_i)_{i \in I}$ a family of elements of X such that $\mu_i(x_i) = 1$ for all $i \in I$. Then the following two properties are equivalent.

a) There exists a T -indistinguishability operator E on X such that

$$\mu_i(x) = E(x, x_i) \quad \forall i \in I \quad \forall x \in X.$$

b) For all $i, j \in I$,

$$\sup_{x \in X} T(\mu_i(x), \mu_j(x)) \leq \inf_{y \in X} E_T(\mu_i(y), \mu_j(y)).$$

Proposition. Let $(\mu_i)_{i \in I}$ be a family of normal fuzzy subsets of X and $(x_i)_{i \in I}$ a family of elements of X such that $\mu_i(x_i) = 1$ for all $i \in I$ satisfying

$$\sup_{x \in X} T(\mu_i(x), \mu_j(x)) \leq \inf_{y \in X} E_T(\mu_i(y), \mu_j(y)).$$

for all $i, j \in I$. Then the T -indistinguishability operator $E = \sup_{i \in I} E^{\mu_i}$ is the smallest T -indistinguishability operator on X satisfying

$$\mu_i(x) = E(x, x_i) \quad \forall i \in I, \quad \forall x \in X.$$

Indistinguishability Operators Between Fuzzy Subsets.

Definition. The *natural T -indistinguishability operator* on $[0, 1]^X$ is defined for all $\mu, \nu \in [0, 1]^X$ by

$$E_T(\mu, \nu) = \inf_{x \in X} E_T(\mu(x), \nu(x)).$$

Geometric Aspects of Indistinguishability Operators

- Archimedean t-norms and pseudo distances
- Betweenness Relations
- S -metrics
- min-indistinguishability Operators

Generalized Metric Spaces

Definition. Let X be a set, (M, \circ, \leq) an ordered semi group with identity element e and m a map $m : X \times X \rightarrow M$. (X, m) is called a **generalized metric space** and m a **generalized metric** on X if and only if for all $x, y, z \in X$

1. $m(x, x) = e$

2. $m(x, y) = m(y, x)$

3. $m(x, y) \circ m(y, z) \geq m(x, z)$.

m separates points if and only if

$$m(x, y) = e \text{ implies } x = y.$$

Examples

- **Metric spaces** are of course generalized metric spaces with $(M, \circ, \leq) = (\mathbb{R}^+, +, \leq)$.
- A set X with a T -indistinguishability operator E is a generalized metric space valued on $([0, 1], T, \leq_T)$. (This encapsulates the very intuitive idea that two objects are similar, equivalent or indistinguishable when they are close and allow us to look at T -indistinguishability operators as similarities and distances at the same time.)
- **S -metrics**. The semi group is the unit interval with a t-conorm S and the usual order.

Homomorphisms Between Indistinguishability Operators

Definition. Given two t -norms T, T' , a T -indistinguishability operator E on a set X and T' -indistinguishability E' on X' , a *morphism* φ between E and E' is a pair of maps $\varphi = (h, f)$ such that the following diagram is commutative

$$\begin{array}{ccc} X \times X & \xrightarrow{E} & [0, 1] \\ \downarrow h \times h & & \downarrow f \\ X' \times X' & \xrightarrow{E'} & [0, 1] \end{array}$$

(i.e. $f(E(x, y)) = E'(h(x), h(y))$ for all $x, y \in X$).

When h and f are bijective maps, φ is called an *isomorphism*.

Maps Between T-indistinguishability Operators

Definition. A *metric transform* is a sub-additive and non-decreasing map $s : [0, \infty) \rightarrow [0, \infty)$ with $s(0) = 0$.

Proposition. Let E be a T -indistinguishability operator on a set X with T a continuous Archimedean t -norm with an additive generator t and f a map $f : [0, 1] \rightarrow [0, 1]$. $f \circ E$ is a T -indistinguishability operator on X if and only if there exists a metric transform s such that the restriction $f|_{\text{Im}(E)}$ of f to the image of E satisfies

$$f|_{\text{Im}(E)} = t^{[-1]} \circ s \circ t.$$

Example

Example. Let $s : [0, \infty) \rightarrow [0, \infty)$ be the map defined by $s(x) = x^\alpha$ for all $x \in [0, \infty)$ with $0 < \alpha \leq 1$. s is a metric transform, since $s(0) = 0$ and

$$s(x + y) = (x + y)^\alpha \leq x^\alpha + y^\alpha = s(x) + s(y).$$

If E is a T -indistinguishability operator on a set X with T the Łukasiewicz t -norm, $t(x) = 1 - x$ an additive generator, then

$$E'(x, y) = f(E(x, y)) = (t^{-1} \circ s \circ t)(E(x, y)) = 1 - (1 - E(x, y))^\alpha$$

is also a T -indistinguishability operator on X .

Let T be the Product t -norm and $t(x) = -\ln x$ an additive generator of T . If E is a T -indistinguishability operator on a set X , then

$E'(x, y) = e^{-(-\ln E(x, y))^\alpha}$ also is a T -indistinguishability operator on X .

min-indistinguishability Operators

Lemma. *Let E be a min-indistinguishability operator on a set X . If for $x, y, z \in X$ $E(x, y) \leq E(y, z) \leq E(x, z)$, then $E(x, y) = E(y, z)$.*

Proposition. *Let E be a min-indistinguishability operator on a set X and $f : [0, 1] \rightarrow [0, 1]$ a map in the unit interval. $f \circ E$ is a min-indistinguishability operator on X if and only if $f(1) = 1$ and f restricted to $\text{Im}(E)$ is a non-decreasing function.*

Indistinguishability Operators and Isomorphic t-norms

Definition. Two continuous t-norms T, T' are *isomorphic* if and only if there exists a bijective map $f : [0, 1] \rightarrow [0, 1]$ such that $f \circ T = T' \circ (f \times f)$.

Isomorphisms f are continuous and increasing maps.

- All strict continuous Archimedean t-norms are isomorphic. In particular, they are isomorphic to the Product t-norm.
- All non-strict continuous Archimedean t-norms are isomorphic. In particular, they are isomorphic to the Łukasiewicz t-norm.

Proposition. *Let f be a bijective map $f : [0, 1] \rightarrow [0, 1]$, T, T' two continuous Archimedean t -norms and t, t' additive generators of T and T' respectively. If f is an isomorphism between T and T' , then there exists $\alpha \in (0, 1]$ such that $f = t'^{[-1]}(\alpha t)$.*

Example. *The only automorphism of the Łukasiewicz t -norm is the identity map.*

Indeed, taking $t(x) = 1 - x$, then $f(x) = 1 - \alpha + \alpha x$ and the only bijective linear map in $[0, 1]$ is the identity.

The automorphisms of the Product t -norm are $f(x) = x^\alpha$ with $\alpha > 0$. More general, the only automorphism of a non-strict Archimedean t -norm is the identity map and for strict t -norms, every $\alpha > 0$ produces an isomorphism f_α with $f_\alpha \neq f_\beta$ if $\alpha \neq \beta$.

Proposition. *If E is a T -indistinguishability operator on a set X for a given t -norm T and f is a continuous, increasing and bijective map $f : [0, 1] \rightarrow [0, 1]$, then $f \circ E$ is a T' -indistinguishability operator with $T' = f \circ T \circ (f^{-1} \times f^{-1})$.*

Proposition. *Let T be a continuous t -norm and E a T -indistinguishability operator on a set X . If $(\mu_i)_{i \in I}$ is a generating family of E and f a continuous, increasing and bijective map $f : [0, 1] \rightarrow [0, 1]$, then $(f \circ \mu_i)_{i \in I}$ is a generating family of the **similar** T' -indistinguishability operator $f \circ E$.*

Corollary. *Similar indistinguishability operators have the same dimension.*

Corollary. *With the preceding notations, $(\mu_i)_{i \in I}$ is a basis of E if and only if $(f \circ \mu_i)_{i \in I}$ is a basis of $f \circ E$.*

Isometries Between Indistinguishability Operators

Definition. Given two sets X, Y and two T -indistinguishability operators E, F on X, Y respectively, a map $\tau : X \rightarrow Y$ is an *isometry* if and only if $E(x, y) = F(\tau(x), \tau(y)) \forall x, y \in X$.

When $E_\mu = E_\nu$?

Theorem. Let T be a continuous Archimedean t -norm, t a generator of T and μ, ν fuzzy subsets of X . $E_\mu = E_\nu$ if and only if $\forall x \in X$ one of the following conditions holds:

a) $t(\mu(x)) = t(\nu(x)) + k_1$ with $k_1 \geq \sup\{-t(\nu(x)) \mid x \in X\}$

or

b) $t(\mu(x)) = -t(\nu(x)) + k_2$ with $k_2 \geq \sup\{t(\nu(x)) \mid x \in X\}$.

Moreover, if T is non-strict, then $k_1 \leq \inf\{t(0) - t(\nu(x)) \mid x \in X\}$ and $k_2 \leq \inf\{t(0) + t(\nu(x)) \mid x \in X\}$.

Example

Example. If T is the Łukasiewicz t -norm, with the previous notations

$$\mu(x) = \nu(x) + k \text{ with } \inf\{1 - \nu(x)\} \geq k \geq \sup_{x \in X}\{-\nu(x)\}$$

or

$$\mu(x) = -\nu(x) + k \text{ with } \inf_{x \in X}\{1 + \nu(x)\} \geq k \geq \sup_{x \in X}\{\nu(x)\}.$$

Example. If T is the product t -norm, then

$$\mu(x) = \frac{\nu(x)}{k} \text{ with } k \geq \sup_{x \in X}\{\nu(x)\}$$

or

$$\mu(x) = \frac{k}{\nu(x)} \text{ with } k \leq \inf_{x \in X}\{\nu(x)\}.$$

When $E_\mu = E_\nu$ for the minimum

Theorem. Let T be the t -norm minimum and let μ be a fuzzy subset of X such that there exists an element x_M of X with $\mu(x_M) \geq \mu(x) \forall x \in X$. Let $Y \subset X$ be the set of elements x of X with $\mu(x) = \mu(x_M)$ and $s = \sup\{\mu(x) \text{ such that } x \in X - Y\}$. A fuzzy subset ν of X generates the same T -indistinguishability operator than μ if and only if

$$\forall x \in X - Y \mu(x) = \nu(x) \text{ and } \nu(y) = t \text{ with } s \leq t \leq 1 \forall y \in Y.$$

Isometries

Theorem. *Let T be a continuous t -norm and E_μ the T -indistinguishability operator on X generated by the fuzzy subset μ of X . The map $\tau : X \rightarrow X$ is an isometry if and only if there exists a fuzzy subset ν of X with $E_\mu = E_\nu$ and $\mu \circ \tau = \nu$.*

Corollary. *Let T be a continuous t -norm and E_μ, E_ν two T -indistinguishability operators on X, Y respectively generated by μ and ν . A bijective map $\tau : X \rightarrow Y$ is an isometry if and only if $\mu = \nu \circ \tau$.*

The group of isometries of $([0, 1], E_T)$

Theorem. Let T be a non-strict continuous Archimedean t -norm T and t an additive generator of T . The group of isometries of $([0, 1], E_T)$ consists of the identity and the strong negation generated by t .

Definition. Given a t -norm T and $a \in [0, 1]$, the map $t_a : [0, 1] \rightarrow [0, 1]$ defined by $t_a(x) = T(a, x)$ will be called the T -translation by a .

Theorem. Let T be a strict continuous Archimedean t -norm. The group of isometries of $([0, 1], E_T)$ is the set of T -translations of $[0, 1]$ (i.e. $\{t_a | a \in [0, 1]\}$).

Theorem. Let T be the t -norm minimum. The group of isometries of $([0, 1], E_T)$ consists of only the identity map.

Relating Indistinguishability Operators and distances

1. If φ is a strong negation, S the dual t-conorm of T with respect to φ and E a T -indistinguishability operator on a set X , then $m = \varphi \circ E$ is an S -metric on X . In particular, if T is greater than or equal to the Łukasiewicz t-norm, then m is a pseudodistance on X that is a distance if and only if E separates points. If T is the minimum t-norm, then m is a pseudoultrametric.
2. If T is a continuous Archimedean t-norm and t an additive generator of T , then E is a T -indistinguishability operator on a set X if and only if $d = t \circ E$ is a pseudodistance on X and E separates points if and only if d is a distance on X .

Definition. Let T be a t -norm and φ a *strong negation*. Then $S = \varphi \circ T \circ \varphi$ is the *dual t -conorm* of T with respect to φ . In this case (T, S, φ) is called a *De Morgan triplet*.

Definition. Given a t -conorm S and a set X a map $m : X \times X \rightarrow [0, 1]$ is an *S -pseudometric* on X if and only if for all $x, y, z \in X$

1. $m(x, x) = 0$
2. $m(x, y) = m(y, x)$
3. $S(m(x, y), m(y, z)) \geq m(x, z)$.

m is an *S -metric* if and only if it also satisfies

$$m(x, y) = 0 \text{ implies } x = y.$$

Duality between S -pseudometrics and T -indistinguishability Operators

Proposition. *Let (T, S, φ) be a De Morgan triplet and X a set. E is a T -indistinguishability operator on X if and only if $m = \varphi \circ E$ is an S -pseudometric on X . E separates points if and only if m is an S -metric.*

Corollary. *Let T be a t -norm greater than or equal to the t -norm of Łukasiewicz. E is a T -indistinguishability on a set X if and only if $m = \varphi \circ E$ is a pseudodistance on X . E separates points if and only if m is a distance on X .*

Indistinguishability Operators and Pseudodistances. Archimedean Case

Proposition. *Let T be a continuous Archimedean t -norm and t an additive generator of T .*

- 1. If d is a pseudo distance on a set X , then $E = t^{[-1]} \circ d$ is a T -indistinguishability operator on X .*
- 2. If E is a T -indistinguishability on X , then $d = t \circ E$ is a pseudo distance on X .*

d is a distance on X if and only if E separates points.

This bijection is not canonical but depends on the generator t . The next proposition relates the distances and indistinguishability operators generated by different additive generators of a t-norm.

Proposition. *Let T be a continuous Archimedean t-norm and t and u two additive generators of T such that $u = \alpha \cdot t$ with $\alpha > 0$.*

1. *If d is a pseudo distance on a set X , $E = t^{[-1]} \circ d$ and $E' = u^{[-1]} \circ d$, then for all $x, y \in X$, $E'(x, y) = t^{[-1]} \left(\frac{d(x, y)}{\alpha} \right)$.*
2. *If E is a T -indistinguishability operator on X , $d = t \circ E$ and $d' = u \circ E$, then for all $x, y \in X$, $d'(x, y) = \alpha \cdot t(E(x, y))$.*

Betweenness Relations

Definition. A *(metric) betweenness relation* on a set X is a ternary relation B on X (i.e. $B \subseteq X^3$) satisfying for all $x, y, z \in X$

1. $(x, y, z) \in B \Rightarrow x \neq y \neq z \neq x$
2. $(x, y, z) \in B \Rightarrow (z, y, x) \in B$
3. $(x, y, z) \in B \Rightarrow (y, z, x) \notin B, (z, x, y) \notin B$
4. $(x, y, z) \in B$ and $(x, z, t) \in B \Rightarrow (x, y, t) \in B$ and $(y, z, t) \in B$.

If $(x, y, z) \in B$, then y is said to be between x and z .

If given any three elements of B , one of them is between the other two, then the betweenness relation is called **linear** or **total**.

If d is a distance defined on a set X , the relation "y is between x and z when $d(x, y) + d(y, z) = d(x, z)$ " satisfies the axioms of a betweenness relation.

Proposition. Let T be a continuous Archimedean t -norm and E a T -indistinguishability operator separating points on a set X such that $E(x, y) \neq 0$ for all $x, y \in X$. The ternary relation B on X defined by $(x, y, z) \in B$ if and only if $x \neq y \neq z \neq x$ and

$$T(E(x, y), E(y, z)) = E(x, z)$$

is a betweenness relation on X .

Proposition. *Let T be a continuous Archimedean t -norm and E a T -indistinguishability operator separating points on X such that there exists $\min\{E(x, y) \mid x, y \in X\} \neq 0$ for all $x, y \in X$. E is one dimensional if and only if the betweenness relation B determined by E on X is linear.*

Corollary. *Let T be a continuous Archimedean t -norm and E a T -indistinguishability operator separating points on a finite set X of cardinality n satisfying $E(x, y) \neq 0 \forall x, y \in X$. E is one dimensional if and only if the cardinality of B is $2 \cdot \binom{n}{3}$.*

Definition. A betweenness relation B on a set X is called *radial* if and only if there exists an element $a \in X$ such that a is between any other two elements of X and these are the only elements of B (i.e. $(x, y, z) \in B$ if and only if $y = a$). The element a is called *the center* of the betweenness relation.

Proposition. Let T be a continuous Archimedean t -norm, E a T -indistinguishability operator separating points on a finite set X of cardinality n satisfying $E(x, y) \neq 0 \forall x, y \in X$ and B the betweenness relation generated on X by E . E is decomposable if and only if B is radial or E can be extended to a T -indistinguishability operator \overline{E} on $\overline{X} = X \cup \{a\}$ with $a \notin X$ in such a way that the betweenness relation \overline{B} generated on \overline{X} by \overline{E} is radial with center a .

The Length of an Indistinguishability Operator and Betweenness Relation

Definition. Given a t -norm T and a T -indistinguishability operator E on a set X , the *length* of E is the maximum $k \in \mathbb{N}$ (if it exists) such that there exists a reflexive and symmetric fuzzy relation R on X with $R^{k-1} \neq R^k = E$ and $\text{length}(E) = \infty$ otherwise.

Note that $\text{length}(E) \geq 1$, since $E^1 = E$, and if X is finite of cardinality n , then $\text{length}(E) \leq n - 1$.

Proposition. Let E be a T -indistinguishability operator on a finite set X of cardinality n . E is one dimensional if and only if $\text{length}(E) = n - 1$.

Proposition. Let E be a T -indistinguishability operator on a finite set X of cardinality n and $\text{length}(E) = k$. Then the dimension of E is less than or equal to $n - k$.

Proposition. Let E be a T -indistinguishability operator on a finite set X and B the betweenness relation defined by E on X . Then, $\text{length}(E) = 1$ if and only if $B = \emptyset$.

Proposition. If E is a decomposable T -indistinguishability operator on a finite set X , then $\text{length}(E) \leq 2$.

Fuzzy Betweenness Relations

Definition. A *fuzzy betweenness relation* with respect to a given strict Archimedean t -norm T on a set X is a fuzzy ternary relation, i.e. a map

$$\begin{aligned} X \times X \times X &\rightarrow [0, 1] \\ (x, y, z) &\rightarrow xyz \end{aligned}$$

satisfying the following properties for all $x, y, z, t \in X$

1. $xxxy = 1$
2. $xyz = zyx$
3. (a) $T(xyz, xzt) \leq xyt$
(b) $T(xyz, xzt) \leq yzt$
4. If $x \neq y$, then $xyx < 1$.

Proposition. *The crisp part of a fuzzy betweenness relation in the set of triplets of different elements of X is a classical betweenness relation on X .*

Proposition. *Let T be a continuous strict Archimedean t -norm and E a T -indistinguishability operator separating points on X with $E(x, y) \neq 0$ for all $x, y \in X$. Then the fuzzy ternary relation on X defined by*

$$xyz = \overrightarrow{T}(E(x, z) | T(E(x, y), E(y, z)))$$

is a fuzzy betweenness relation.

Reciprocally,

Proposition. *Let T be a continuous strict Archimedean t -norm. If xyz is a fuzzy betweenness relation on a set X , then the fuzzy relation E on X defined by $E(x, y) = xyx$ is T -indistinguishability operators on X .*

Replacing an Indistinguishability Operator by a low dimensional One

Example. Let T be the product t -norm and E the T -indistinguishability operator on the set $X = \{1, 2, 3, 4, 5\}$ of cardinality 5 given by the following matrix

$$\begin{pmatrix} 1 & 0.74 & 0.67 & 0.50 & 0.41 \\ 0.74 & 1 & 0.87 & 0.65 & 0.53 \\ 0.67 & 0.87 & 1 & 0.74 & 0.60 \\ 0.50 & 0.65 & 0.74 & 1 & 0.80 \\ 0.41 & 0.53 & 0.60 & 0.80 & 1 \end{pmatrix} .$$

The associated fuzzy betweenness relation is given by the table in the next slide.

x	y	z	xyz	x	y	z	xyz	x	y	z	xyz	x	y	z	xyz
1	2	3	0.96	2	3	1	0.79	3	4	1	0.55	4	5	1	0.66
1	2	4	0.96	2	3	4	0.99	3	4	2	0.55	4	5	2	0.65
1	2	5	0.96	2	3	5	0.98	3	4	5	0.99	4	5	3	0.65
1	3	2	0.79	2	4	1	0.44	3	5	1	0.37	5	1	2	0.57
1	3	4	0.99	2	4	3	0.55	3	5	2	0.37	5	1	3	0.46
1	3	5	0.98	2	4	5	0.98	3	5	4	0.65	5	1	4	0.26
1	4	2	0.44	2	5	1	0.29	4	1	2	0.57	5	2	1	0.96
1	4	3	0.55	2	5	3	0.37	4	1	3	0.45	5	2	3	0.77
1	4	5	0.98	2	5	4	0.65	4	1	5	0.26	5	2	4	0.46
1	5	2	0.29	3	1	2	0.57	4	2	1	0.96	5	3	1	0.98
1	5	3	0.37	3	1	4	0.45	4	2	3	0.76	5	3	2	0.98
1	5	4	0.66	3	1	5	0.46	4	2	5	0.43	5	3	4	0.56
2	1	3	0.57	3	2	1	0.96	4	3	1	0.99	5	4	1	0.98
2	1	4	0.57	3	2	4	0.76	4	3	2	0.99	5	4	2	0.98
2	1	5	0.57	3	2	5	0.77	4	3	5	0.56	5	4	3	0.99

The dimension of E is 3. Nevertheless it is close to the one-dimensional T -indistinguishability operator E' with matrix

$$\begin{pmatrix} 1 & 0.76 & 0.67 & 0.50 & 0.40 \\ 0.76 & 1 & 0.88 & 0.68 & 0.53 \\ 0.67 & 0.88 & 1 & 0.75 & 0.60 \\ 0.50 & 0.66 & 0.75 & 1 & 0.80 \\ 0.40 & 0.53 & 0.60 & 0.80 & 1 \end{pmatrix}$$

whose associated fuzzy betweenness relation is shown in the next slide.

x	y	z	xyz	x	y	z	xyz	x	y	z	xyz	x	y	z	xyz
1	2	3	1	2	3	1	0.78	3	4	1	0.56	4	5	1	0.64
1	2	4	1	2	3	4	1	3	4	2	0.56	4	5	2	0.64
1	2	5	1	2	3	5	1	3	4	5	1	4	5	3	0.64
1	3	2	0.78	2	4	1	0.43	3	5	1	0.36	5	1	2	0.58
1	3	4	1	2	4	3	0.56	3	5	2	0.36	5	1	3	0.45
1	3	5	1	2	4	5	1	3	5	4	0.64	5	1	4	0.25
1	4	2	0.43	2	5	1	0.28	4	1	2	0.58	5	2	1	1
1	4	3	0.56	2	5	3	0.36	4	1	3	0.45	5	2	3	0.78
1	4	5	1	2	5	4	0.64	4	1	5	0.25	5	2	4	0.43
1	5	2	0.28	3	1	2	0.58	4	2	1	1	5	3	1	1
1	5	3	0.36	3	1	4	0.45	4	2	3	0.78	5	3	2	1
1	5	4	0.64	3	1	5	0.45	4	2	5	0.43	5	3	4	0.56
2	1	3	0.58	3	2	1	1	4	3	1	1	5	4	1	1
2	1	4	0.58	3	2	4	0.78	4	3	2	1	5	4	2	1
2	1	5	0.58	3	2	5	0.78	4	3	5	0.56	5	4	3	1

The crisp part of the fuzzy betweenness relation generated by E' is a linear betweenness relation, since its cardinality is $2 \cdot \binom{5}{3}$.

Calculation of the Dimension

Definition. Let E be a T -indistinguishability on a set X . In H_E we define the following relation \leq_H

$$\mu \leq_H \nu \text{ if and only if } E_\mu \geq E_\nu.$$

Lemma. \leq_H is a reflexive and transitive relation.

We define an equivalence relation \sim on H_E in order to obtain a partial ordering:

$$\mu \sim \nu \text{ if and only if } E_\mu = E_\nu.$$

Definition. The quotient set H_E / \sim will be denoted H_E^p and $\mu \in H_E$ will be called maximal if and only if its equivalence class $\bar{\mu}$ is maximal on H_E^p .

Lemma. *Let M be the set of maximal elements of H_E . Then M is a generating family of E .*

Proposition. *Let $(\mu_i)_{i \in I}$ be a generating family of E . Then there exists a generating family $(\mu'_i)_{i \in I}$ of maximal generators with the same index set.*

Corollary. *It is always possible to find a basis of maximal elements for a given T -indistinguishability operator.*

If μ is a generator of a given T -indistinguishability operator E on $X = \{a_1, a_2, \dots, a_n\}$, then $E_\mu \geq E$ or, in a more explicit way,

$$E_T(\mu(a_i), \mu(a_j)) \geq E(a_i, a_j) \quad \forall i, j = 1, 2, \dots, n.$$

Proposition. *The set of generators of a T -indistinguishability operator E on X is the solution of the following system of inequalities:*

$$\overrightarrow{T}(\max(x_i, x_j) | \min(x_i, x_j)) \leq E(a_i, a_j) \quad 0 \leq x_i, x_j \leq 1 \quad i, j = 1, 2, \dots,$$

Proposition. *If T is the Product t-norm, then H_E is the polyhedron solution of the system of inequalities*

$$x_i - E(a_i, a_j) \cdot x_j \leq 0 \quad 0 \leq x_i, x_j \leq 1 \quad i, j = 1, 2, \dots, n.$$

Proposition. *If T is the Łukasiewicz t-norm, then H_E is the polyhedron solution of the system of inequalities*

$$x_i - x_j \leq 1 - E(a_i, a_j) \quad 0 \leq x_i, x_j \leq 1 \quad i, j = 1, 2, \dots, n.$$

Proposition. *If T is the minimum t-norm, then H_E is the solution of system of inequalities*

$$\min(x_i, x_j) \geq E(a_i, a_j) \quad x_i \neq x_j \quad 0 \leq x_i, x_j \leq 1 \quad i, j = 1, 2, \dots, n.$$

Proposition. *If T is the Product or the Łukasiewicz t -norm, then the elements of a basis of a T -indistinguishability operator E are located in the (hyper) faces of H_E .*

Proposition. *If T is the product or the Łukasiewicz t -norm, then it is always possible to find a basis of E with all its elements on the edges of H_E .*

Since the elements of a preceding basis belong to different edges and, since the number of edges is finite, a method to calculate a basis of E can be derived:

Procedure to calculate a basis of a T -indistinguishability E on a finite set X (cardinality of $X = n$) for T the Łukasiewicz or the Product t-norm:

1. Calculate the edges of the set H_E .
2. $Count = 1$.
3. Build a set A obtained taking a generator from each edge of H_E .
4. Define $B(Count) =$ the set of subsets of A of $Count$ elements.
5. Select a set H of $B(Count)$ and build the T -indistinguishability operator E_H generated by H .
6. If $E_H = E$ then end.
7. Do step 5 and step 6 for all different elements of $B(Count)$.
8. $Count = Count + 1$. Go to 4.

Example. Let us consider the Product-indistinguishability operator E on a set X of cardinality 4 represented by the matrix

$$\begin{pmatrix} 1 & 0.12 & 0.41 & 0.13 \\ 0.12 & 1 & 0.12 & 0.23 \\ 0.41 & 0.12 & 1 & 0.27 \\ 0.13 & 0.23 & 0.27 & 1 \end{pmatrix}$$

The set of edges in this case is

$$\begin{aligned} & \{(0.12 \quad 1.00 \quad 0.29 \quad 0.23), \quad (0.41 \quad 0.12 \quad 1.00 \quad 0.52), \\ & (0.12 \quad 1.00 \quad 0.25 \quad 0.92), \quad (0.41 \quad 0.12 \quad 1.00 \quad 0.27), \\ & (0.12 \quad 1.00 \quad 0.29 \quad 0.92), \quad (0.66 \quad 0.23 \quad 0.27 \quad 1.00), \\ & (0.12 \quad 1.00 \quad 0.12 \quad 0.44), \quad (1.00 \quad 0.12 \quad 0.48 \quad 0.13), \\ & (0.12 \quad 1.00 \quad 0.12 \quad 0.23), \quad (1.00 \quad 0.12 \quad 0.41 \quad 0.13), \\ & (0.13 \quad 0.23 \quad 0.32 \quad 1.00), \quad (1.00 \quad 0.12 \quad 0.41 \quad 0.52), \\ & (0.13 \quad 0.23 \quad 0.27 \quad 1.00), \quad (1.00 \quad 0.12 \quad 1.00 \quad 0.27), \\ & (0.29 \quad 1.00 \quad 0.12 \quad 0.44), \quad (1.00 \quad 0.12 \quad 1.00 \quad 0.52), \\ & (0.29 \quad 1.00 \quad 0.12 \quad 0.23), \quad (1.00 \quad 0.57 \quad 0.41 \quad 0.13), \\ & (0.35 \quad 1.00 \quad 0.85 \quad 0.23), \quad (1.00 \quad 0.57 \quad 0.48 \quad 0.13)\} \end{aligned}$$

and a basis is

$$\{(0.12 \quad 1.00 \quad 0.25 \quad 0.92), \quad (0.29 \quad 1.00 \quad 0.12 \quad 0.23)\}.$$

When the cardinality of the universe of discourse X is 3, there is a nice geometric interpretation of these results.

Example. The set of generators H_E of the Product-indistinguishability operator E on $X = \{a_1, a_2, a_3\}$ with matrix

$$\begin{pmatrix} 1 & 0.23 & 0.37 \\ 0.23 & 1 & 0.26 \\ 0.37 & 0.26 & 1 \end{pmatrix}$$

is the part of the pyramid with vertex on the origin of coordinates with edges passing through the points A, B, C, D, E, F contained in $[0, 1]^3$.

$$A = (0.37, 0, 26, 1) \quad B = (1, 0.23, 0.86)$$

$$C = (1, 0.23, 0.37) \quad D = (0.72, 1, 0.26)$$

$$E = (0.23, 1, 0.26) \quad F = (0.23, 1, 0.61).$$

E is bidimensional and a basis of E is given by the two fuzzy subsets

$$B = (1, 0.23, 0.86) \quad F = (0.23, 1, 0.61).$$

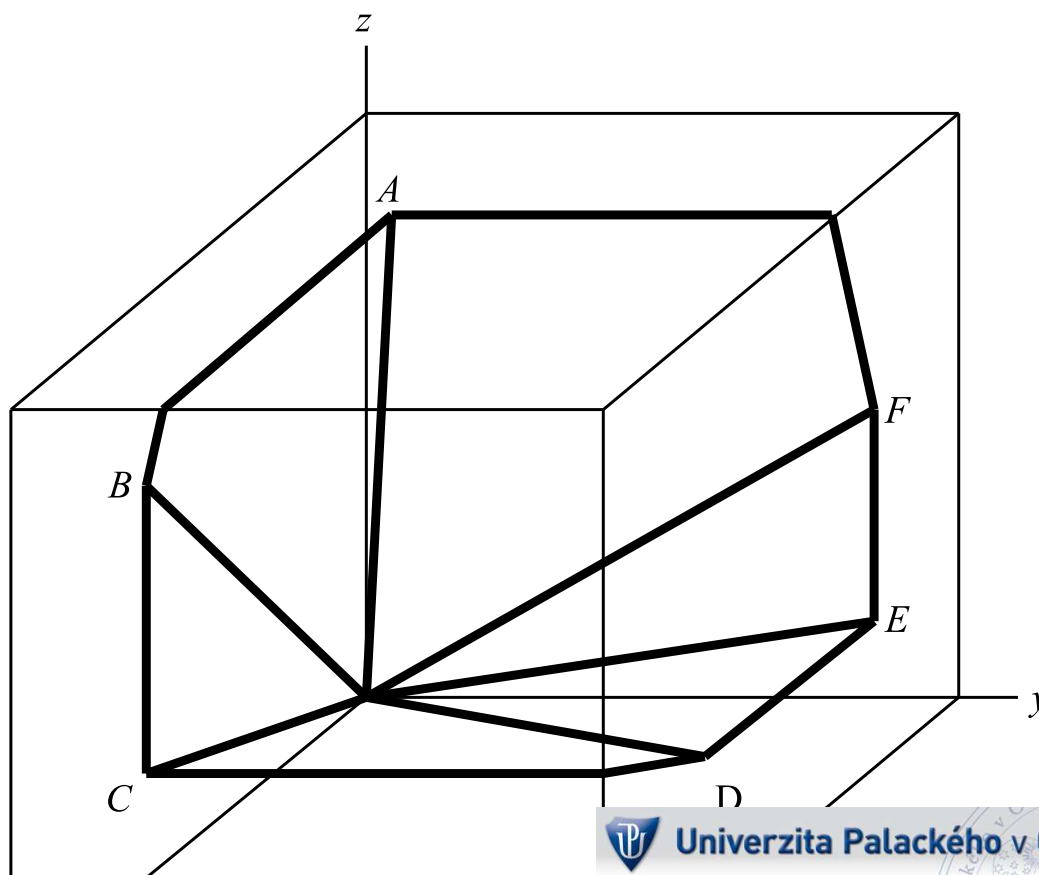

Example. The set of generators H_E of the T -indistinguishability operator E on $X = \{a_1, a_2, a_3\}$ (T the Łukasiewicz t -norm) with matrix

$$\begin{pmatrix} 1 & 0.32 & 0.42 \\ 0.32 & 1 & 0.36 \\ 0.42 & 0.36 & 1 \end{pmatrix}$$

is the part of the prism with edges parallel to the line $x = y = z$ passing through the points A, B, C, D, E, F contained in $[0, 1]^3$.

$$\begin{aligned} A &= (0.68, 0, 0.64) & B &= (0.68, 0, 0.1) \\ C &= (0.58, 0.64, 0) & D &= (0, 0.68, 0.04) \\ E &= (0, 0.68, 0.58) & F &= (0.06, 0, 0.64). \end{aligned}$$

A basis of E is given by the two fuzzy subsets

$$A = (0.68, 0, 0.64) \quad B = (0.68, 0, 0.1)$$

and E is bidimensional.

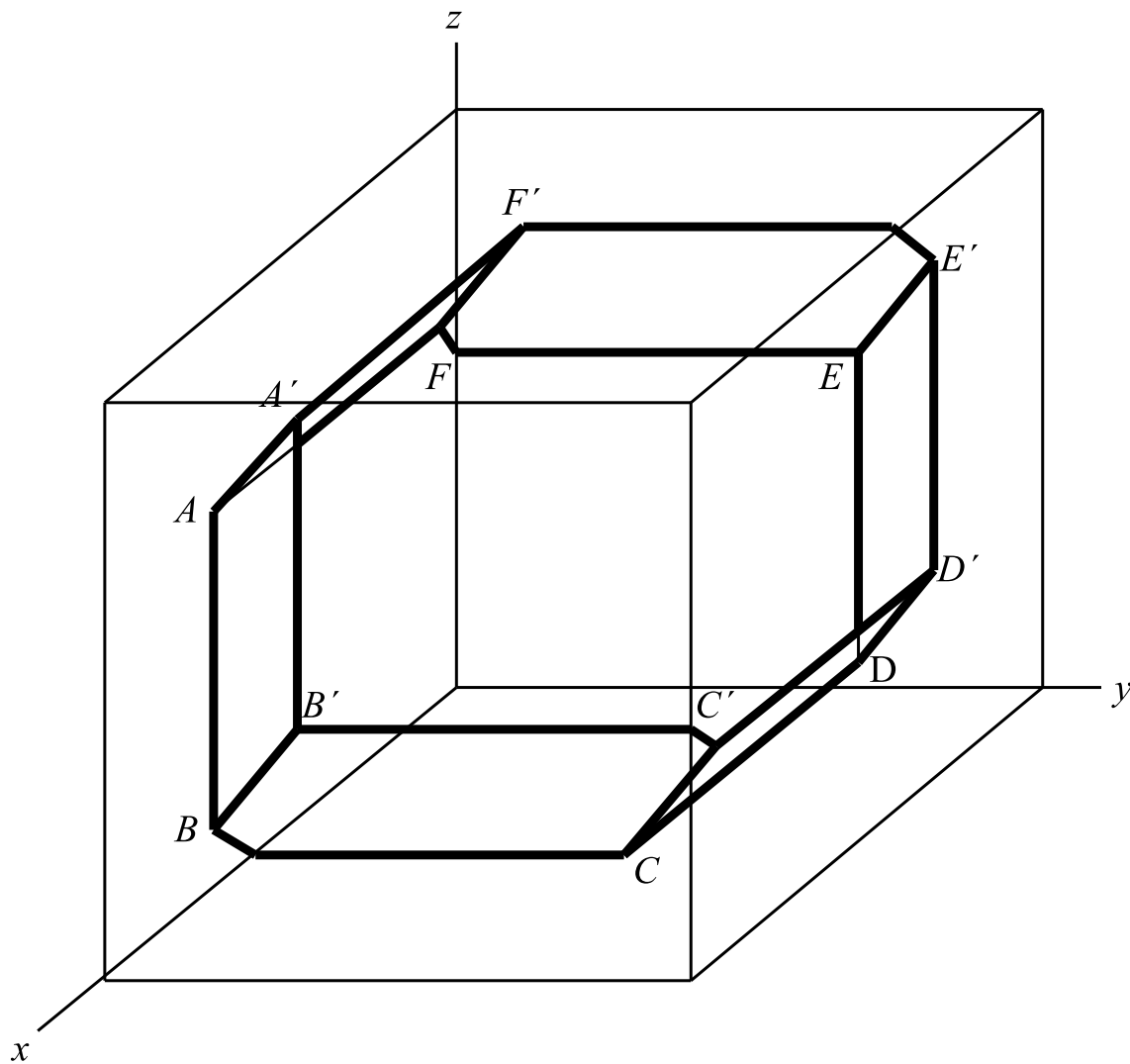

Transitive closure

Let R be a reflexive and symmetric fuzzy relation on a finite set $X = \{a_1, a_2, \dots, a_n\}$ of cardinality n and T the Łukasiewicz t-norm.

Let us recall that $R \leq \bar{R}$ and if E is another T -indistinguishability operator on X satisfying $R \leq E$, then $\bar{R} \leq E$.

$H_{\bar{R}}$ is the polyhedron solution of the system of inequalities

$$x_i - x_j \leq 1 - \bar{R}(a_i, a_j) \quad 0 \leq x_i, x_j \leq 1 \quad i, j = 1, 2, \dots, n.$$

But this system is equivalent to

$$x_i - x_j \leq 1 - R(a_i, a_j) \quad 0 \leq x_i, x_j \leq 1 \quad i, j = 1, 2, \dots, n.$$

Therefore from R we can calculate the set $H_{\bar{R}}$ and from here we can calculate \bar{R} finding a basis and then generating \bar{R} from it.

Note that the inequalities

$$x_i - x_j < 1 - R(a_i, a_j) \text{ with } R(a_i, a_j) < \overline{R}(a_i, a_j)$$

are superfluous and therefore the numbers $\overline{R}(a_i, a_j)$ that are greater than $R(a_i, a_j)$ are \mathbb{Q} -linear combination of the $\overline{R}(a_i, a_j)$ that coincide with their respective $R(a_i, a_j)$. Therefore, the more numbers $R(a_i, a_j)$ different from their corresponding $\overline{R}(a_i, a_j)$, the less edges will have $H_{\overline{R}}$ and the smaller its dimension. In other words,

The farther a reflexive and symmetric relation R is from its transitive closure \overline{R} , the smaller the dimension of \overline{R} .

min-indistinguishability Operators

Definition. A map $m : X \times X \rightarrow \mathbb{R}$ is a *pseudo ultrametric* if and only if for all $x, y, z \in X$

1. $m(x, x) = 0$.
2. $m(x, y) = m(y, x)$.
3. $\max(m(x, y), m(y, z)) \geq m(x, z)$.

If $m(x, y) = 0$ implies $x = y$, then it is called an *ultrametric*.

Balls of Ultrametrics

Proposition. *Let m be an ultrametric on X . Then*

- 1. If $B(x, r)$ denotes the **ball of centre x and radius r** and $y \in B(x, r)$, then $B(x, r) = B(y, r)$. (All elements of a ball are its centre).*
- 2. If two balls have non-empty intersection, then one of them is contained in the other one.*

Proposition. *Let E be a fuzzy relation on a set X . E is a min-indistinguishability operator on X if and only if $m = 1 - E$ is a pseudo ultrametric.*

Corollary. *The cardinality of $\text{Im}(E) = \{E(x, y)\}$ is smaller than or equal to the cardinality of X . In particular, if X is finite of cardinality n and E is identified with a matrix, then the number of different entries of the matrix is less or equal than n .*

Definition. *Let E be a fuzzy relation on X and $\alpha \in [0, 1]$, the α -cut of E is the set E_α of pairs $(x, y) \in X \times X$ such that $E(x, y) \geq \alpha$.*

Proposition. *Let E be a fuzzy relation on X . E is a min-indistinguishability operator on X if and only if for each $\alpha \in [0, 1]$, the α -cut of E is an equivalence relation on X .*

min-indistinguishability Operators and Hierarchical Trees

Definition. A *hierarchical tree* of a finite set X is a sequence of partitions A_1, A_2, \dots, A_k of X such that every partition refines the preceding one.

A *hierarchical tree is indexed* if every partition A_i has associated a non-negative number λ_i and $\lambda_i < \lambda_{i+1}$ for all $i = 1, 2, \dots, k - 1$.

Proposition. Every min-indistinguishability operator E on a finite set X generates an indexed hierarchical tree on X .

Reciprocally,

Proposition. Every indexed hierarchical tree A_1, A_2, \dots, A_k of a finite set X with $\lambda_k = 1$ generates a min-indistinguishability operator E on X .

Example. Let $X = \{a, b, c, d, e\}$ and E the min-indistinguishability operator with matrix

$$\begin{array}{c}
 \\
 a \\
 b \\
 c \\
 d \\
 e
 \end{array}
 \begin{array}{ccccc}
 & a & b & c & d & e \\
 \left(\begin{array}{ccccc}
 1 & 0.5 & 0.2 & 0.2 & 0.2 \\
 0.5 & 1 & 0.2 & 0.2 & 0.2 \\
 0.2 & 0.2 & 1 & 0.2 & 0.2 \\
 0.2 & 0.2 & 0.2 & 1 & 0.7 \\
 0.2 & 0.2 & 0.2 & 0.7 & 1
 \end{array} \right) .
 \end{array}$$

The corresponding tree is

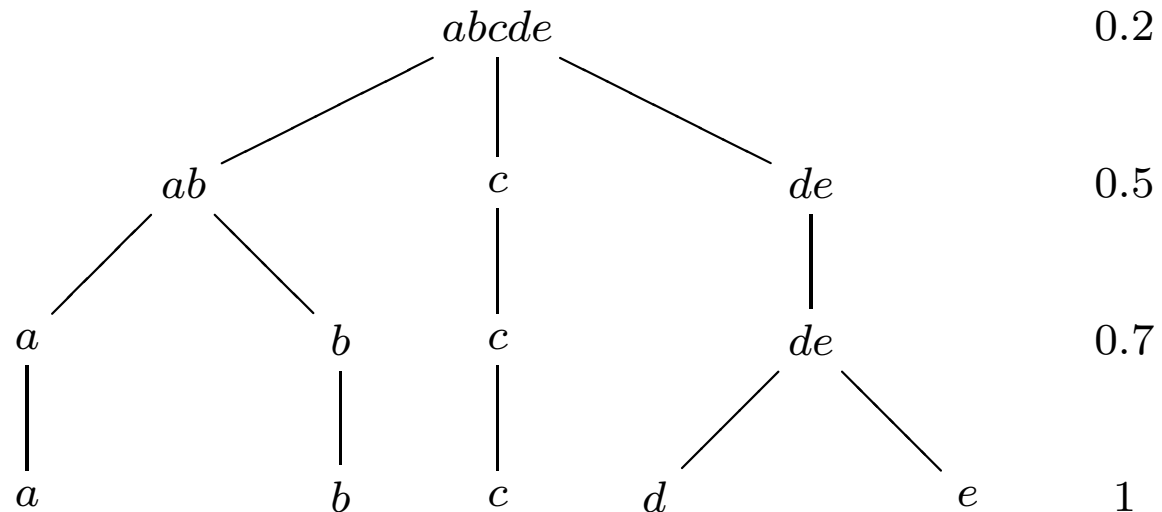

References

- Boixader, D., Jacas, J., Recasens, J.: Fuzzy equivalence relations: advanced material. In: Dubois, D., Prade, H. (eds.) *Fundamentals of Fuzzy Sets*, pp. 261-290. Kluwer Academic Publishers, New York (2000)
- Boixader, D., Jacas, J., Recasens, J.: Upper and lower approximation of fuzzy sets. *Int. J. of General Systems* 29, 555-568 (2000)
- Bou, F., Esteva, F., Godo, L., Rodríguez, R.: On the Minimum Many-Valued Modal Logic over a Finite Residuuated Lattice. *Journal of Logic and computation* (2010) doi:10.1093/logcom/exp062
- Calvo, T., Kolesárova, A., Komorníková, M., Mesiar, R.: Aggregation Operators: Properties, Classes and Construction Methods. In: Mesiar, R., Calvo, T., Mayor, G. (eds.) *Aggregation Operators: New Trends and Applications*, pp. 3-104. *Studies in Fuzziness and Soft Computing*, Springer (2002)
- Castro, J.L., Klawonn, F.: Similarity in Fuzzy Reasoning. *Mathware & Soft Computing* 2, 197-228 (1996)
- Dawyndt, P., De Meyer, H., De Baets, B.: The complete linkage clustering algorithm revisited. *Soft Computing* 9 85-392 (2005)

- De Baets, B., De Meyer, H.: Transitive approximation of fuzzy relations by alternating closures and openings. *Soft Computing* 7 210-219 (2003)
- Demirci, M.: Fuzzy functions and their fundamental properties. *Fuzzy Sets and Systems* 106, 239-246 (1999)
- Demirci, M. Fundamentals of M-vague algebra and M-vague arithmetic operations. *International Journal of Uncertainty, Fuzziness and Knowledge-Based Systems* 10, 25-75 (2002)
- Demirci, M.: Foundations of fuzzy functions and vague algebra based on many-valued equivalence relations part I: fuzzy functions and their applications, part II: vague algebraic notions, part III: constructions of vague algebraic notions and vague arithmetic operations, *Int. J. General Systems* 32, 123-155, 157-175, 177-201 (2003)
- Demirci, M., Recasens, J.: Fuzzy Groups, Fuzzy Functions and Fuzzy Equivalence Relations. *Fuzzy Sets and Systems* 144, 441-458 (2004)
- Di Nola, A., Sessa, S., Pedrycz, W., Sánchez, E.: Fuzzy relation equations and their applications to knowledge engineering. Kluwer Academic Publishers, New York (1989)

- Dubois, D., Ostasiewicz, W., Prade, H.: Fuzzy Sets: History and basic notions. In: Dubois, D, Prade, H. (eds.) Fundamentals of Fuzzy Sets, pp. 21-124. Kluwer Academic Publishers, New York (2000)
- Esteva, F., Garcia, P., Godo, L.: Relating and extending semantical approaches to possibilistic reasoning. International Journal of Approximate Reasoning 10, 311-344 (1995)
- Fodor, J.C., Roubens, M.: Structure of transitive valued binary relations. Math. Soc. Sci. 30, 71-94 (1995)
- Godo, L., Rodriguez, R.O.: Logical approaches to fuzzy similarity-based reasoning: an overview. In: Riccia, G., Dubois, D., Lenz, H.J., Kruse, R. Preferences and Similarities, pp. 75-128. CISM Courses and Lectures 504 Springer (2008)
- Gottwald, S.: Fuzzy Sets and Fuzzy Logic: the Foundations of Application from a Mathematical Point of View. Friedr. Vieweg & Sohn Verlagsgesellschaft mbH, Wiesbaden (1993)
- Gottwald, S., Bandemer, H.: Fuzzy Sets, Fuzzy Logic, Fuzzy Methods. Wiley, New York (1996)

- Hajek P.: Metamathematics of fuzzy logic. Kluwer Academic Publishers, New York (1998)
- Jacas, J.: Similarity Relations - The Calculation of Minimal Generating Families. Fuzzy Sets and Systems 35, 151-162 (1990)
- Jacas, J.: Fuzzy Topologies induced by S-metrics. The Journal of fuzzy mathematics 1, 173-191 (1993)
- Jacas, J., Recasens, J.: Fixed points and generators of fuzzy relations. J. Math. Anal. Appl 186, 21-29 (1994)
- Jacas, J., Recasens, J.: Fuzzy T-transitive relations: eigenvectors and generators. Fuzzy Sets and Systems 72, 147-154 (1995)
- Jacas, J., Recasens, J.: Maps and Isometries between indistinguishability operators. Soft Computing 6, 14-20 (2002)
- Jacas, J., Recasens, J.: Aggregation of T-Transitive Relations. Int J. of Intelligent Systems 18, 1193-1214 (2003)
- Klawonn, F.: Fuzzy Points, Fuzzy Relations and Fuzzy Functions. In: Nov'ak, V., Perfilieva, I. (eds.) Discovering the World with Fuzzy Logic, pp. 431-453. Physica-Verlag, Heidelberg (2000)

- Klawonn, F., Kruse, R.: Equality Relations as a Basis for Fuzzy Control. *Fuzzy Sets and Systems* 54, 147-156 (1993)
- Klement, E.P., Mesiar, R., Pap E.: *Triangular norms*. Kluwer Academic Publishers, Dordrecht (2000)
- Morsi, N.N., Yakout, M.M.: Axiomatics for fuzzy rough sets. *Fuzzy Sets and Systems* 100, 327-342 (1998)
- Recasens, J.: The Structure of Decomposable Indistinguishability Operators. *Information Sciences* 178, 4094-4104 (2008)
- Trillas, E.: Assaig sobre les relacions d'indistingibilitat. Proc. Primer Congrés Català de Lògica Matemàtica, Barcelona, 51-59 (1982) (In Catalan)
- Valverde, L.: On the Structure of F-indistinguishability Operators. *Fuzzy Sets and Systems* 17, 313-328 (1985)
- Zadeh, L.A. Similarity relations and fuzzy orderings. *Inform. Sci.* 3, 177-200 (1971)
- Zadeh, L.A.: Fuzzy sets and information granularity. In: Gupta, M.M., Ragade, R.K., Yager, R.R. (eds.) *Advances in Fuzzy Set Theory and Applications*, pp. 3-18. Amsterdam, North-Holland (1979)
- Zadeh, L.A.: Toward a theory of fuzzy information granulation and its centrality in human reasoning and fuzzy logic. *Fuzzy Sets*