

Enhancing Quantum Optomechanics by Squeezed Light

A. A. Rakhubovsky N. Vostrosablin R. Filip

Department of Optics, UPOL

LPHYS'16



Palacký University
Olomouc

1 Introduction

Optomechanics

Quantum Nondemolition Interaction

2 The Main Part

State Upload With QND Optomechanics

QND Interface Between Distant Mechanical Modes

3 Conclusion

The Basic Model Of Optomechanical System

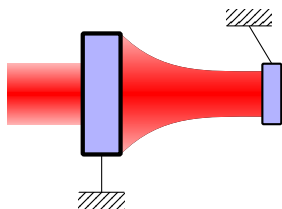

$$\hat{H} = \hbar\omega_{\text{cav}}(\hat{x})\hat{a}^\dagger\hat{a} \approx \hbar \left[\omega_{\text{cav}} + \hat{x} \frac{\partial\omega_{\text{cav}}}{\partial x} \right] \hat{a}^\dagger\hat{a}$$

$$\xrightarrow{\text{Linearization}} \hat{H}_{\text{int}} = -\hbar g_0 \sqrt{\langle n_{\text{cav}} \rangle} \hat{X} \hat{x}$$

$$\hat{H}_{\text{full}} = \hbar\Delta(X^2 + Y^2) + \hbar\omega_m(x^2 + p^2) + \hat{H}_{\text{int}}$$

Mechanics

- Macroscopic Quantum Mechanics
- Couples to everything (microwaves, optics)
- Large Q ($\sim 10^6$)

QND coupling in Optomechanics

$$H_{\text{full}} = \hbar\Delta(X^2 + Y^2) + \hbar\omega_m(x^2 + p^2) + \hbar g X x$$

- Good cavity ($\kappa \ll \omega_m$) Modulate the pump at mechanical frequency / Create the two sidebands of the optomechanical cavity
 - V. B. Braginsky et al., Science, **209**, 547 (1980)
 - A.A. Clerk et al., New J. Phys, **10**, 095010 (2008)
- Bad cavity ($\kappa \gg \omega_m$) Very short pulses (M. Vanner et al., PNAS, **108**, 16182)

Squeezing

$$(X, Y) \longrightarrow (SX, S^{-1}Y)$$

$$H = \hbar g X x \longrightarrow H = \hbar g S X x.$$

QND Enhancement By Squeezing

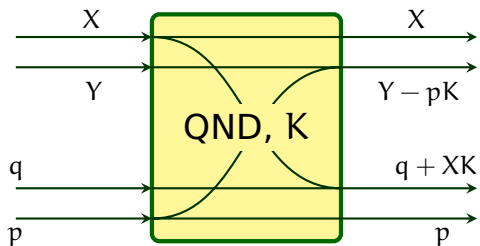

QND Enhancement By Squeezing

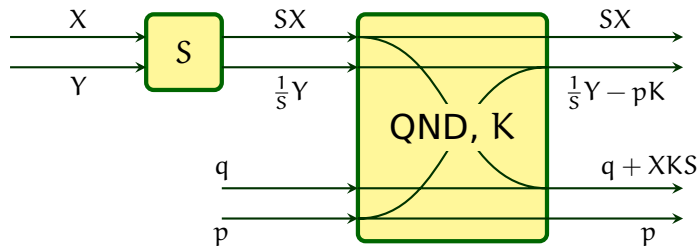

QND Enhancement By Squeezing

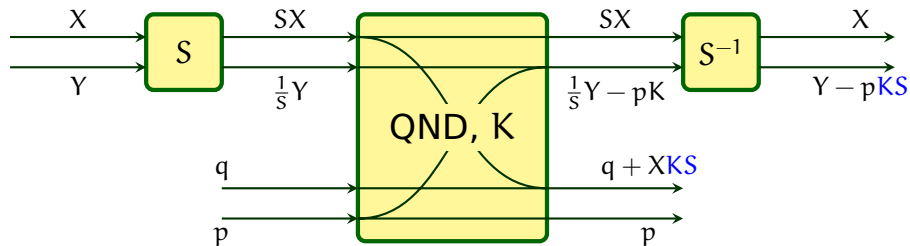

QND Enhancement By Squeezing

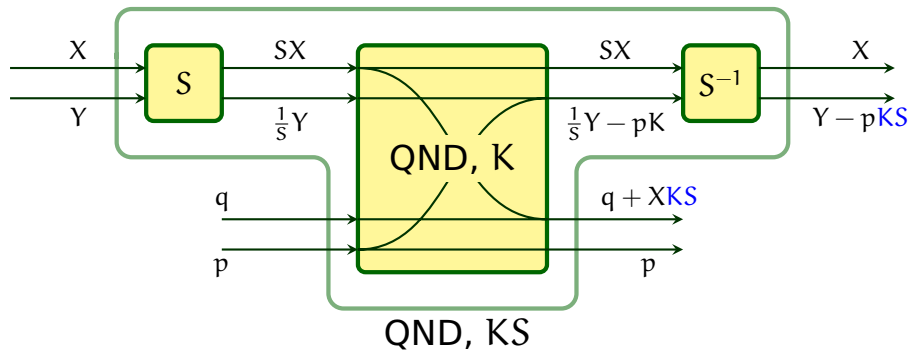

Interface Scheme [PRA, **93**,033813]

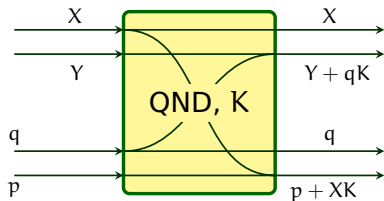

After QND

$$q \rightarrow q(0)$$

$$p \rightarrow p(0) + KX ;$$

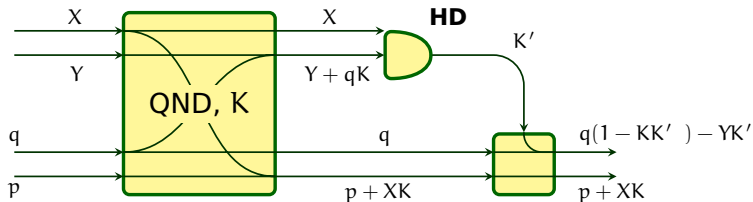
Interface Scheme [PRA, **93**,033813]

After Feedforward

$$q \rightarrow q(0)(1 - KK') - YK'$$

$$p \rightarrow p(0) + KX ;$$

Interface Scheme [PRA, **93**,033813]

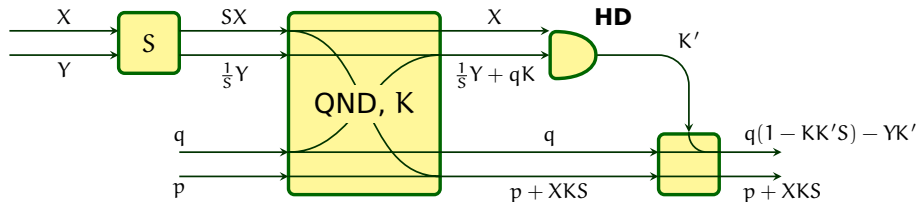

After Optical Presqueezing and Feedforward

$$q \rightarrow q(0)(1 - KK'S) - YK'$$

$$p \rightarrow p(0) + KXS;$$

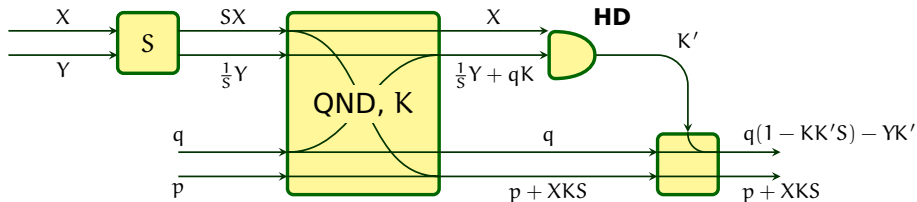
Interface Scheme [PRA, **93**,033813]

After Optical Presqueezing and Feedforward

$$q_f = \sigma \left(q_0 \sqrt{1 - T} - \sqrt{T} Y \right),$$

$$p_f = \frac{1}{\sigma} \left(p_0 \sqrt{1 - T} + \sqrt{T} X \right),$$

$$T = \frac{1}{1 + (KS)^{-2}}, \quad \sigma^2 = K'/KS.$$

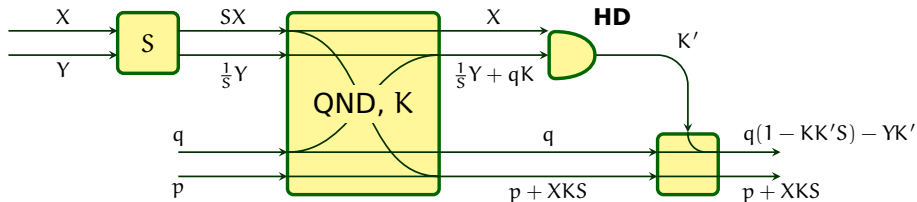
Interface Scheme [PRA, **93**,033813]

After Optical Presqueezing and Feedforward

$$q_f = \sigma \left(q_0 \sqrt{1 - T} - \sqrt{T} Y \right),$$

$$p_f = \frac{1}{\sigma} \left(p_0 \sqrt{1 - T} + \sqrt{T} X \right),$$

$$T = \frac{1}{1 + (KS)^{-2}}, \quad \sigma^2 = K'/KS.$$

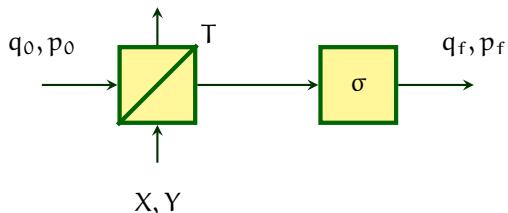

Excess Noise

$$q_f = q_0 \sqrt{1-T} - \sqrt{T} Y,$$

$$p_f = p_0 \sqrt{1-T} + \sqrt{T} X.$$

$$V_N = \sqrt{\text{var } q_0 \times \text{var } p_0},$$

$$V_N < \frac{T}{1-T}$$

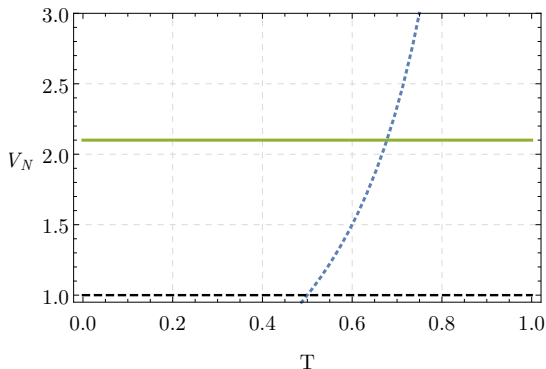

Optomechanical Implementation

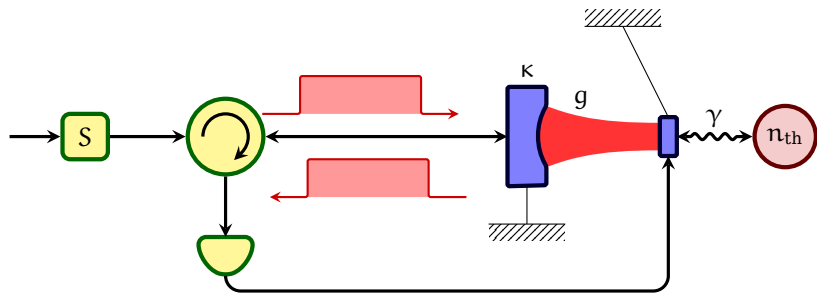

- Resolved sideband $\omega_m \gg \kappa$
- Long pulses $\kappa\tau \gg 1$
- QND coupling $K = g\sqrt{\frac{2\tau}{\kappa}}$
- Mechanical mode is precooled close to ground state

Imperfections

Cavity Mode

- Adds vacuum noise
- Distorts the shape of the pulse

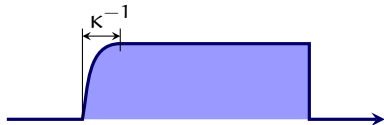

Imperfections

Cavity Mode

- Adds vacuum noise
- Distorts the shape of the pulse



Bath

- Distorts the shape of the pulse
- Adds thermal noise $\sim \tau\gamma n_{th}$

State Upload (Full Solution)

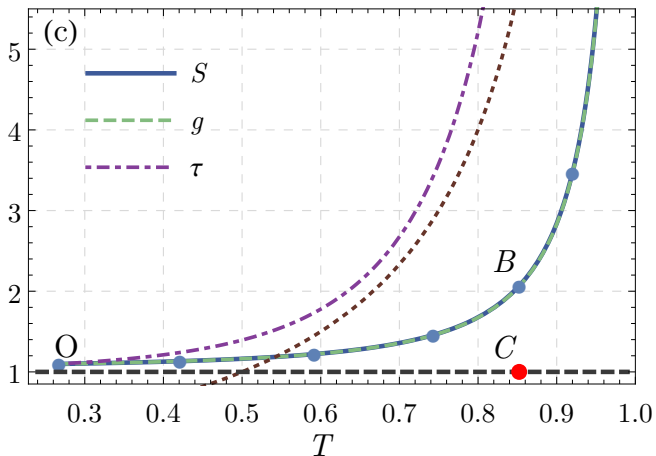

For parameters of [Meenehan et al., PRX:**5**, 041002 (2015)]

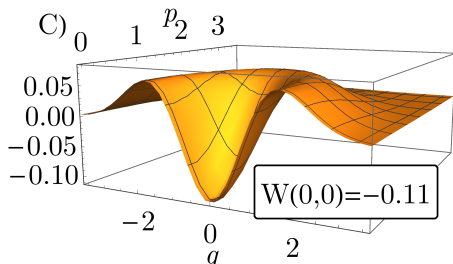
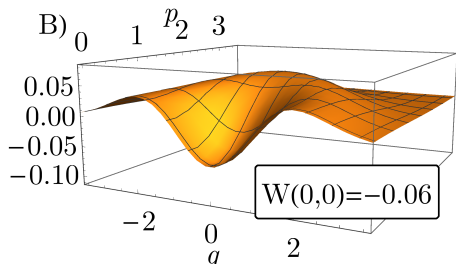
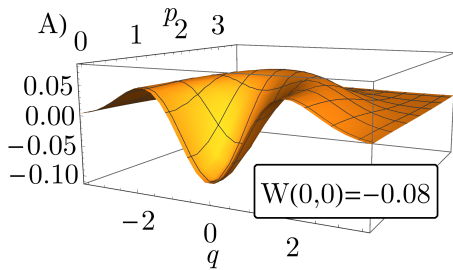
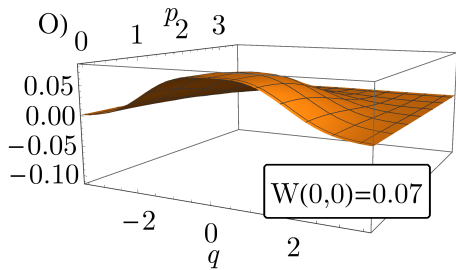
Transfer of Negativity of $|1\rangle$ 

State Upload (Solution Without Cavity Mode)

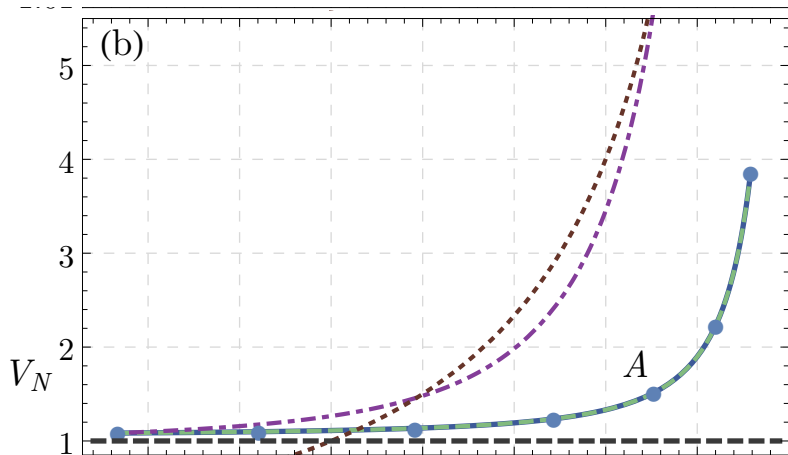

Desired outcome

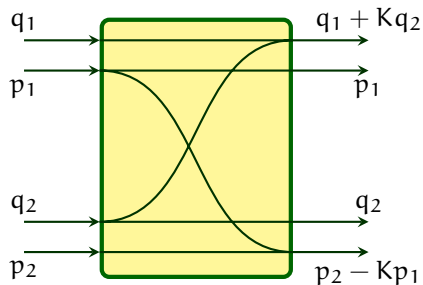

Principal Performance

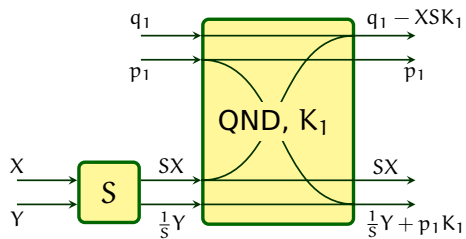

Principal Performance

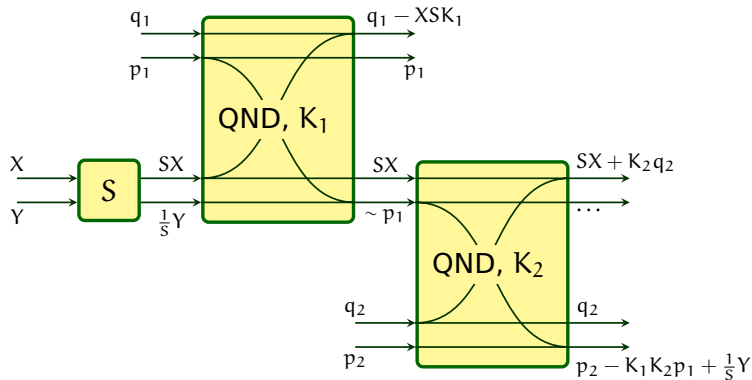

Principal Performance

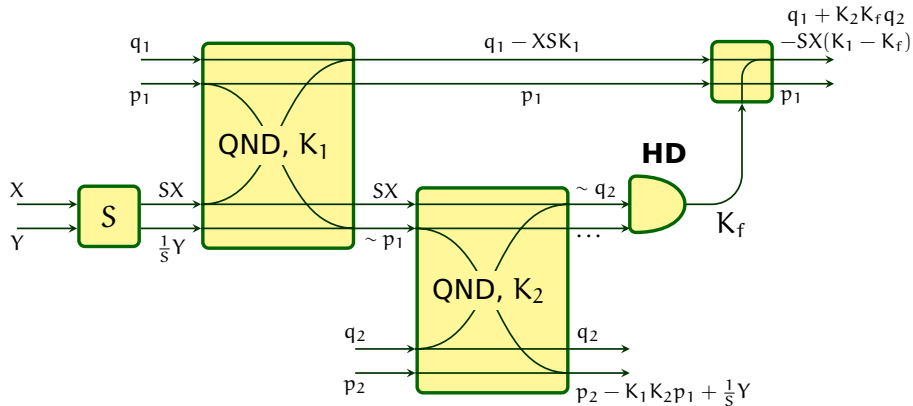

Possible Implementation

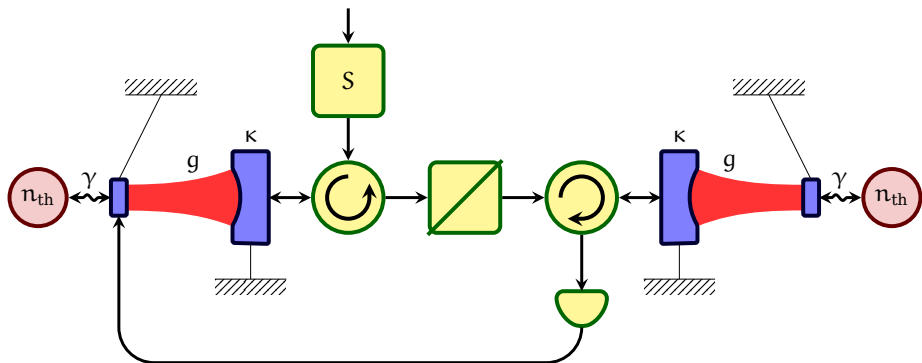

- Resolved sideband
- Long pulses
- Mechanics is left pre-cooled just before the corresponding interaction

Coupling

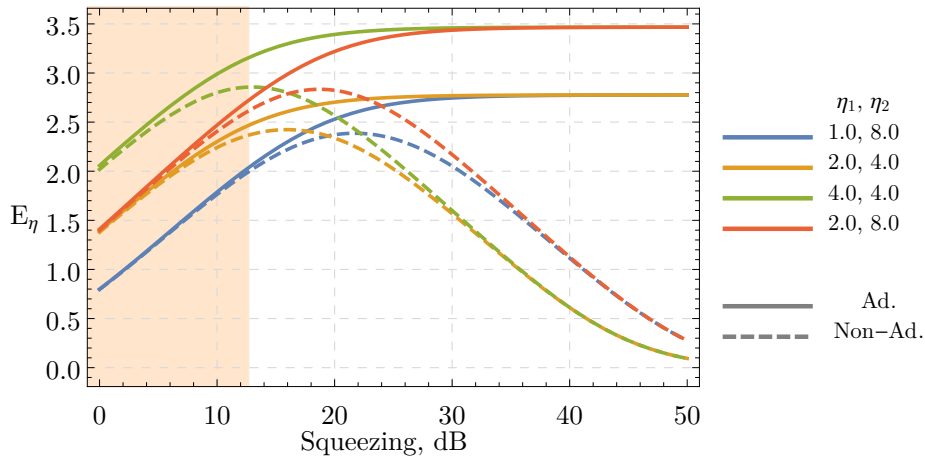

Loss and noise

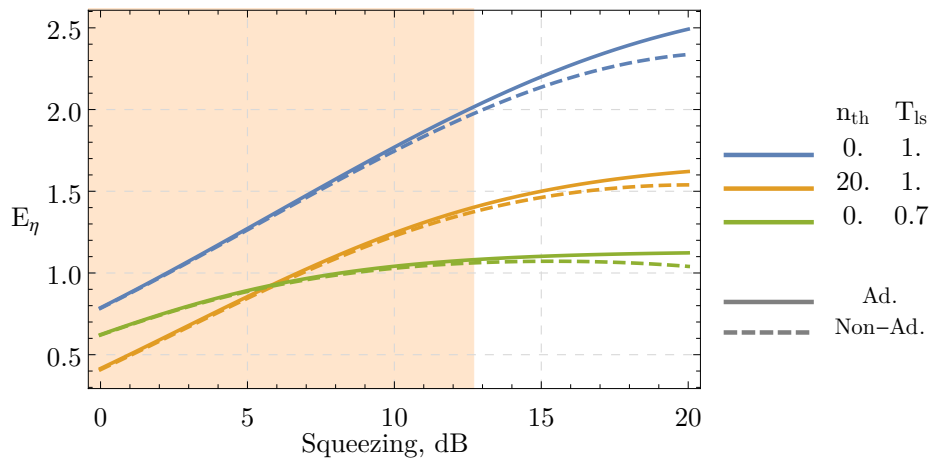

Optimized

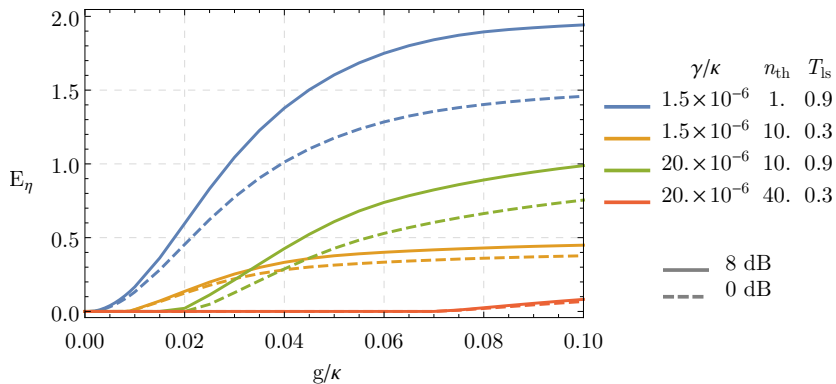

Conclusion

State Upload [PRA:**93**, 033813 (2016), arXiv: 1511.08611]

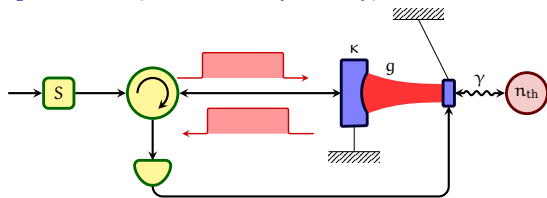

QND interface [arXiv:1605.05932]

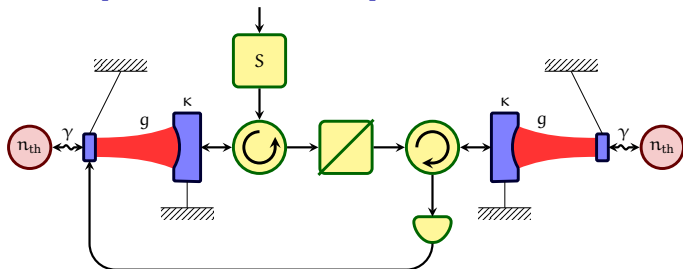

Thank You!