

Nonlinear Stroboscopic Quantum Optomechanics

Andrey Rakhubovsky and Radim Filip

Department of Optics, Palacký University, 17. Listopadu 12, 771 46 Olomouc, Czech Republic
andrey.rakhubovsky@gmail.com



Palacký University
Olomouc

INTRODUCTION

We present feasible experimental proposals to construct an optomechanical transducer entangling radiation modes by quadratic nonlinearities and to prepare a cubic phase state of mechanical oscillator. We show robustness of both protocols to thermal noise.

Optomechanical transducer based on the geometric phase effect

In this part of the poster we propose a transducer [1, 2] in which two possibly disparate modes of radiation are sequentially interacting to the mechanical mediator via pulsed quantum nondemolition optomechanical coupling [3]. As a result of the sequence of four pulses, the mechanical mode traverses a closed path in the phase space, and the geometric phase is introduced.

The mechanical mode thereby is effectively traced out of the transformations of the modes of the radiation, and the latter are entangled by highly pure quadratic nonlinearity between the modes. Importantly, a proper optimization of the coupling rates of the individual interactions allows the protocol to function at high environmental temperatures even in presence of the losses for the radiation modes.

Cubic phase state of mechanical motion

This, based on the unpublished work, part of the poster focuses on a stroboscopic preparation of a cubic phase state [4] of a mechanical mode of an optomechanical system by stroboscopic application of a nonlinear potential. Such a state is an important prerequisite to

the universal quantum computation with continuous variables. We prove that it is possible to obtain a nonlinear state given an initial motional state of moderate purity in presence of a hot mechanical environment. We also show that the application of such a protocol is within experimental reach in the domain of the optomechanical systems with levitated nanoparticles [5, 6].

Both stroboscopic protocols take advantage of optimization of the sequence of the pulsed interactions to reach high robustness to the mechanical thermal environment. The proposals open extensions of stroboscopic methods [7] and experiments [8] to complex and highly nonlinear systems.

OPTOMECHANICAL TRANSDUCER BASED ON THE GEOMETRIC PHASE EFFECT

Two pulses of radiation, A and B, interact sequentially in turns with a shared thermal mechanical oscillator via a QND-type coupling $H_{\text{int}} \propto Q_{A,B} Q_M$. After four interactions the pulses are coupled via a QND coupling $H \propto Q_A Q_B$ and the mechanical mode is traced out.

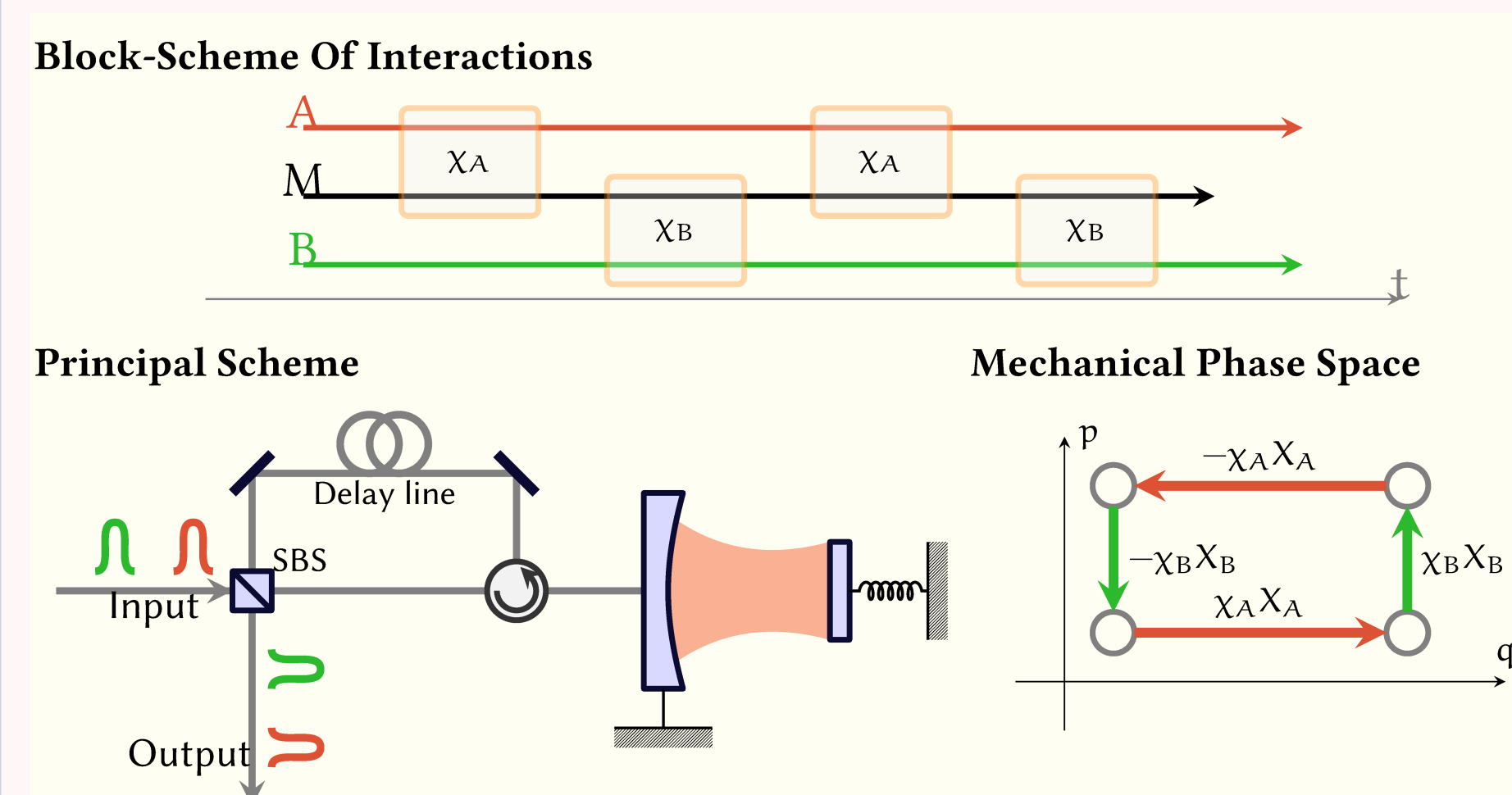

Conditional and generalized squeezing

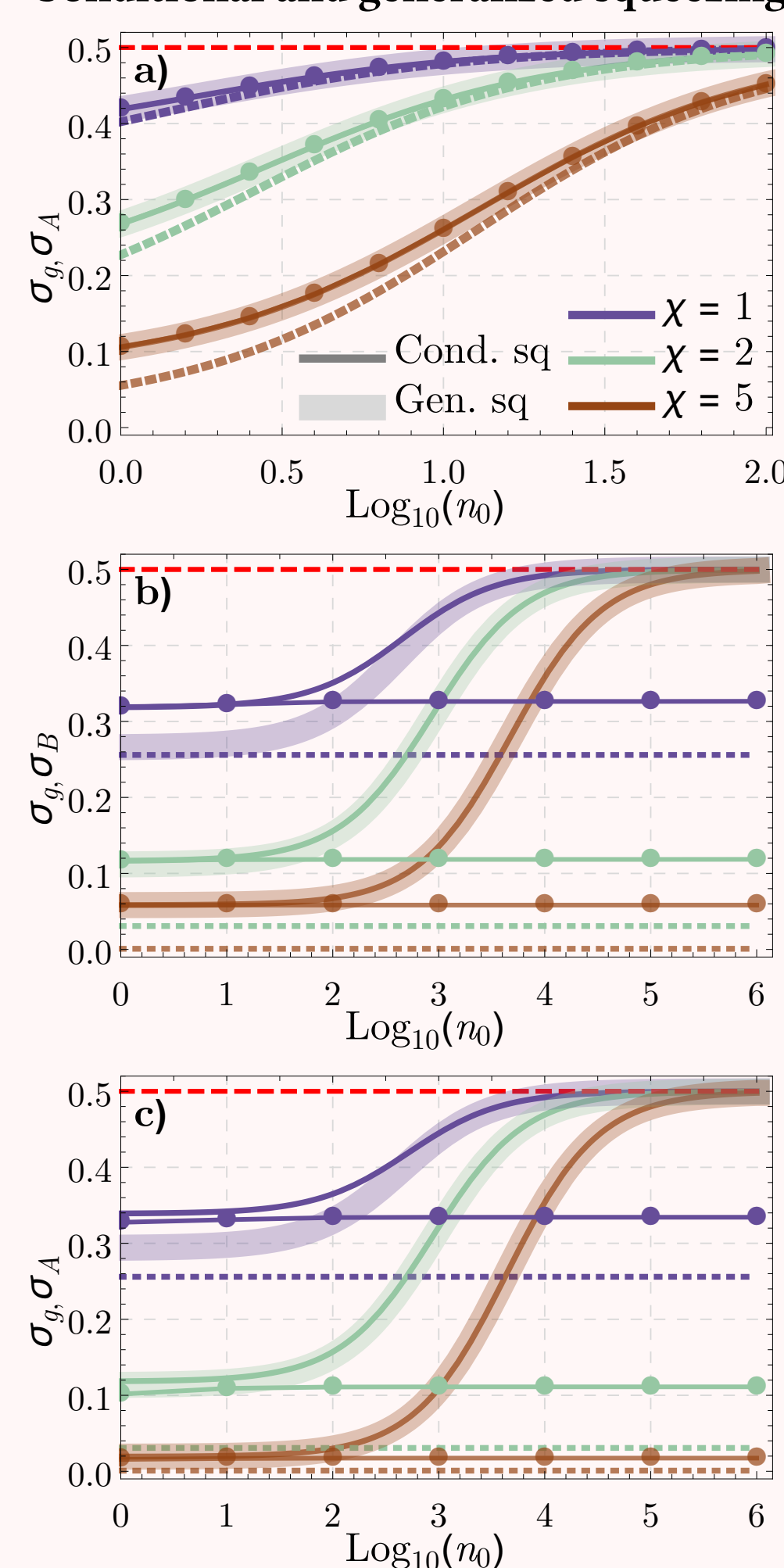

Entanglement and Steering after three interactions

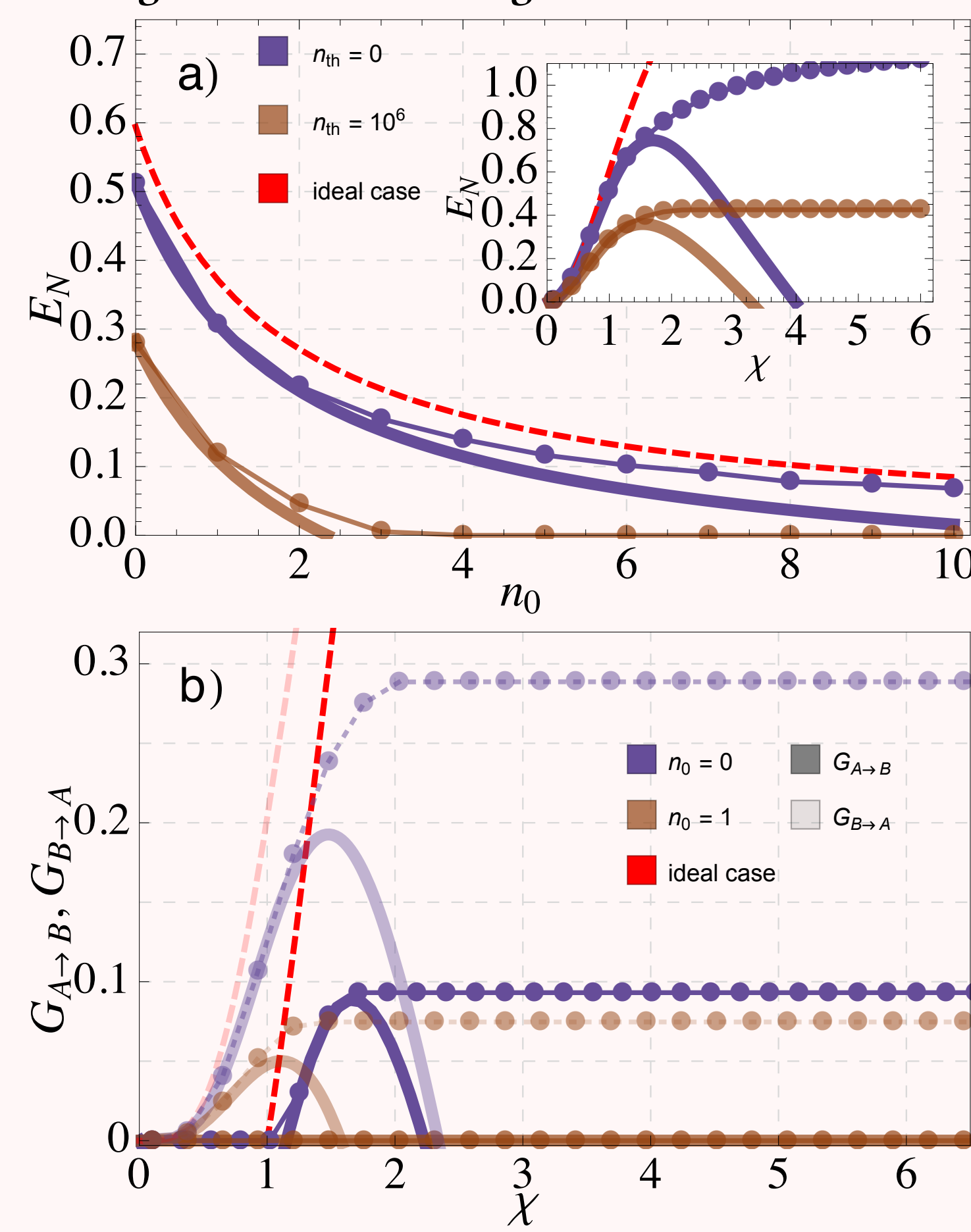

Entanglement and Steering after four interactions

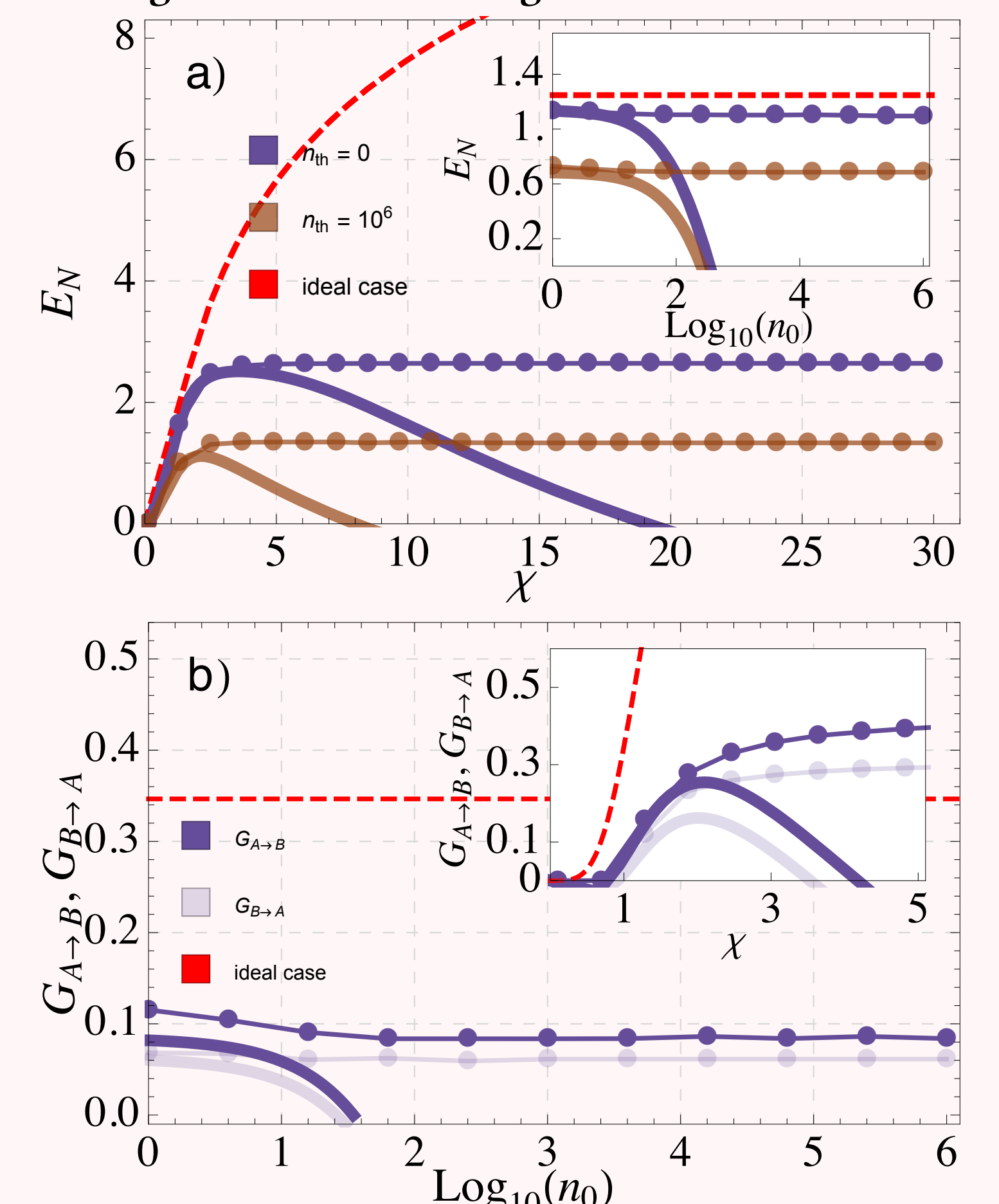

CUBIC PHASE STATE OF MECHANICAL MOTION [ARXIV:1904.00773]

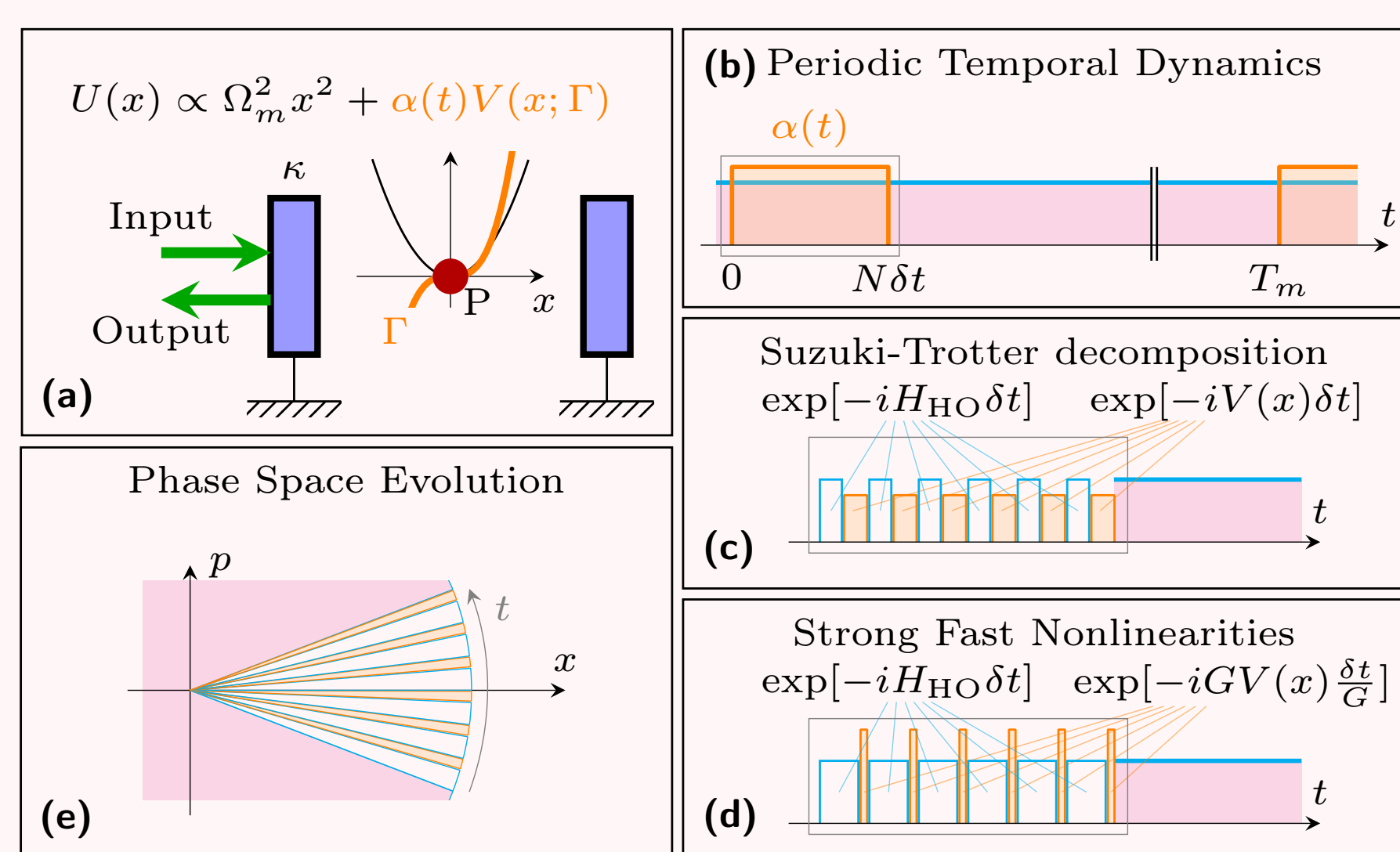

(a) A levitated optomechanical system. A dielectric subwavelength particle (P) is trapped by a tweezer (not shown) within a high-Q cavity κ . The particle feels a total potential $U(x)$ that is a sum of the harmonic and the nonlinear parts, both provided by the trapping beam. The particle can be probed by the laser light. (b) The nonlinear part of the potential is switched on for only a fraction of the mechanical period. Such an evolution can be approximated by a sequence of pulsed interactions as in (c,d). Orange sectors represent action of the nonlinear potential, cyan sectors without fill represent the harmonic evolution, pink filled sector denotes damped harmonic evolution. (e) Phase space picture of the evolution over a single mechanical period.

Nonlinear Squeezing and Wigner Functions

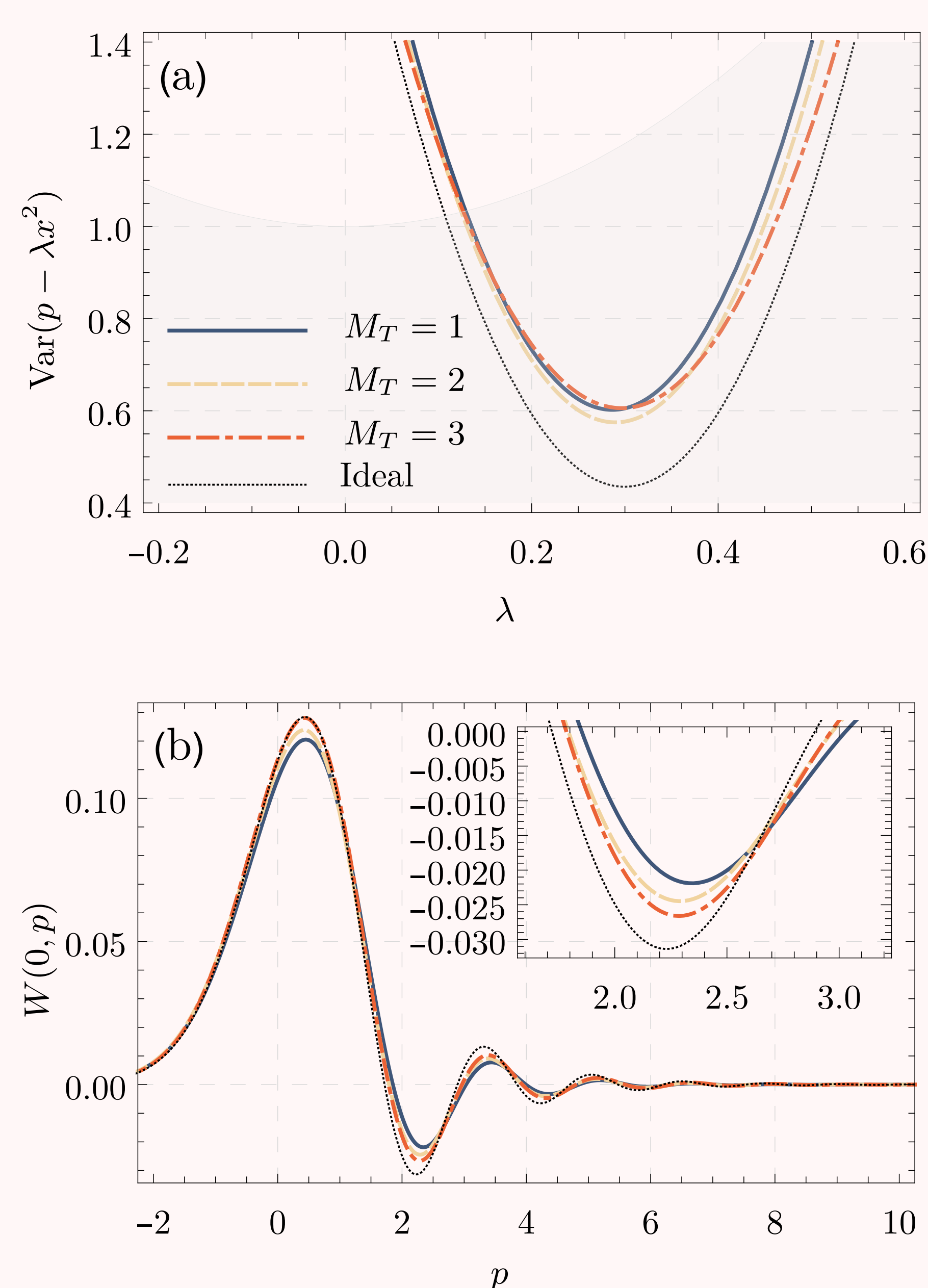

We apply Suzuki-Trotter decomposition to approximate evolution

$$\mathcal{U}(t + N\delta t, t) = \left[\exp[-i(H_{\text{HO}} + V(x))\delta t] \right]^N \approx \left[\mathcal{U}_{\text{HO}}(\delta t) \mathcal{U}_{\text{NL}}(\delta t) + O(\delta t^2) \right]^N,$$

The resulting states approximate the Cubic Phase State

$$W_{\text{CPS}}(x, p) \propto \text{Ai} \left[\left(\frac{4}{3\Gamma} \right)^{1/3} (3\Gamma x^2 - p) \right],$$

and possess the squeezing in the nonlinear variable below the shot-noise level:

$$\text{Var}(p - \lambda x^2) \leq \sigma_{\text{vac}}.$$

Squeezing of the initial mechanical state reduces the requirements on cooling.

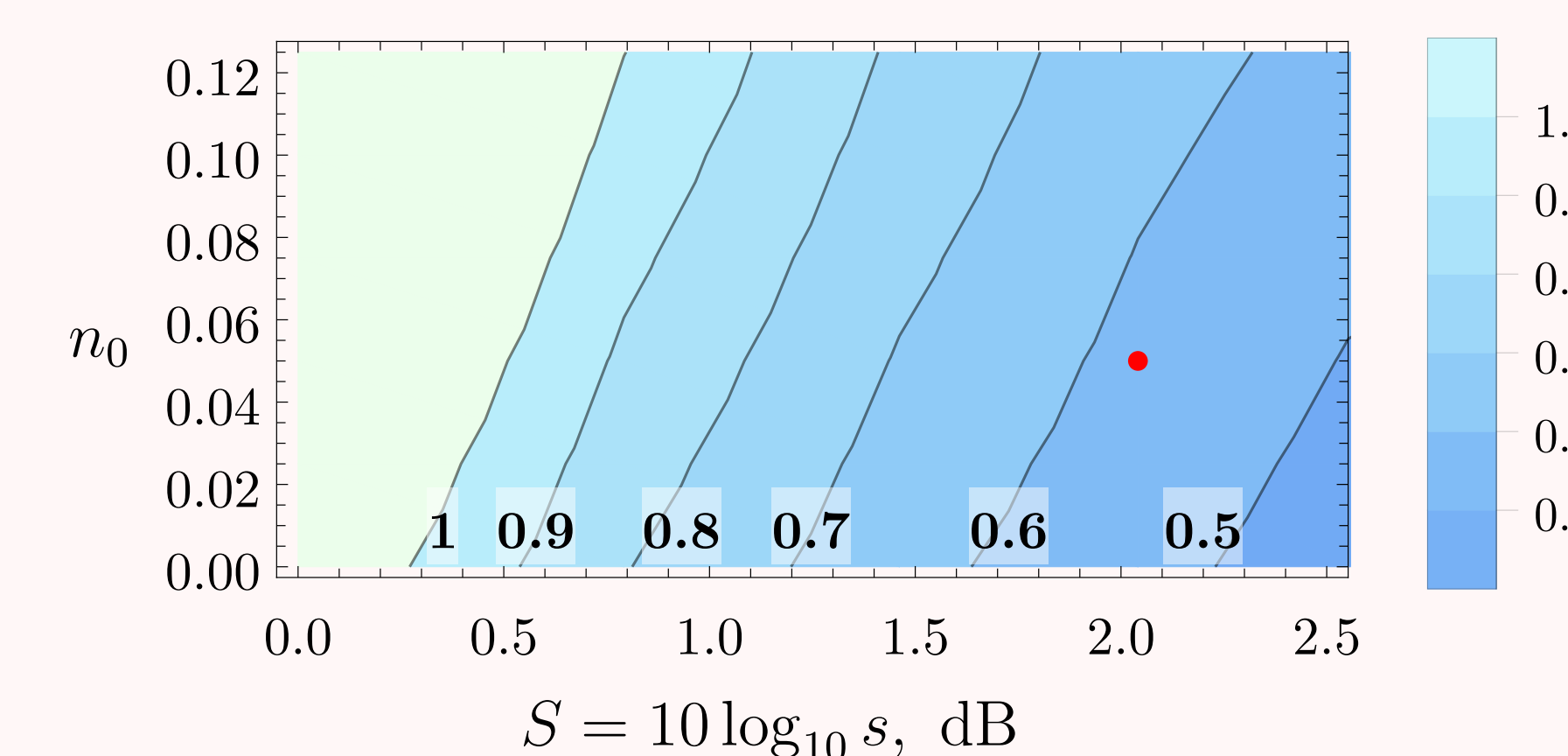

REFERENCES

References

- [1] N. Vostrosablin et al., Optics Express **25**, 18974 (2017).
- [2] N. Vostrosablin et al., New Journal of Physics **20**, 083042 (2018).
- [3] M. Aspelmeyer et al., Reviews of Modern Physics **86**, 1391 (2014).
- [4] D. Gottesman et al., Physical Review A **64**, 012310 (2001).
- [5] D. E. Chang et al., Proceedings of the National Academy of Sciences **107**, 1005 (2010).
- [6] O. Romero-Isart et al., Physical Review A **83**, 013803 (2011).
- [7] M. R. Vanner et al., Proceedings of the National Academy of Sciences **108**, 16182 (2011).
- [8] M. R. Vanner et al., Nature Communications **4**, 2295 (2013).